

Proprietors : ILIFFE & SONS LTD.
Managing Editor : HUGH S. POCKOCK, F.I.E.E.
Editor : H. F. SMITH

Editorial, Advertising and Publishing Offices :
DORSET HOUSE, STAMFORD STREET
LONDON, S.E.1.

Telephone : Waterlo 3333 (60 lines).
Telegrams : "Echaworld Sedist London."

PUBLISHED MONTHLY

Price : 1 6

(Publication date 26th of preceding month)

Subscription Rate : 20/- per annum. Home and Abroad

Branch Offices :

Birmingham : King Edward House, New Street, 2.
Coventry : 8-10, Corporation Street.
Glasgow : 26B, Renfield Street, C.2.
Manchester : 260, Deansgate, 3

In this Issue

OUR COVER; Pye Br8T Chassis (See Page 458)

EDITORIAL COMMENT	431
CATHODE-RAY OSCILLOSCOPE By S. A. Knight	432
CIRCUIT SYMBOLS By L. H. Bainbridge-Bell	437
TELEVISION WAVEFORMS	439
AERIAL CORONA INTERFERENCE By F. R. W. Trafford ..	441
BRITISH COMPONENTS IN SWEDEN	443
ELECTRONIC CIRCUITRY	444
HIGHLIGHTS OF CAR RADIO	445
MANUFACTURERS' PRODUCTS	446
THE SEE-SAW CIRCUIT AGAIN By J. McG. Sowerby ..	447
WORLD OF WIRELESS	450
STABILIZED POWER SUPPLIES—3. By M. G. Scroggie ..	453
ECONOMICAL 50-WATT AMPLIFIER By G. R. Woodville	457
INVISIBLE COMPONENTS By "Cathode Ray"	459
SHORT-WAVE CONDITIONS	463
UNBIASED By "Free Grid"	464
LETTERS TO THE EDITOR	465
RANDOM RADIATIONS By "Diallist"	468
RECENT INVENTIONS	470

2845



New Approach COMPONENTS

Keeping abreast of fast-moving technical development calls for a new approach to production problems. The "WEARITE" Pressed Circuit System represents a substantial advance in production science to speed assembly and lower costs. The first of these "Wearite" New Approach Components is a Coil Pack comprising coils, switches, trimmers and padders completely wired and ready for instant incorporation into any standard Superhet circuit.

Sides removed for clarity of illustration

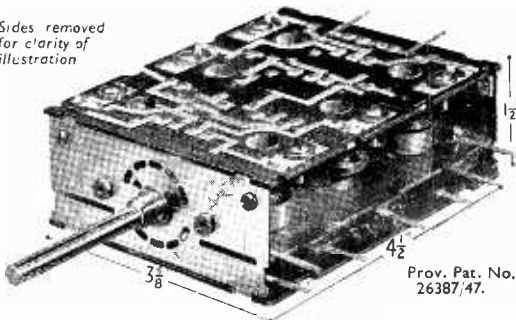

- 3 ranges
- Gram switching
- 2-hole fixing at 1 3/8" centres
- All trimmers and adjusters conveniently placed in one surface

Owing to raw material restrictions, supplies, for the time being, are confined to Radio Receiver Manufacturers at home and abroad.

Manufacturers are urged to write for full technical details.

Wright and Weaire Limited

138, SLOANE ST. · LONDON · S.W.1 TEL. SLOANE 221415 FACTORY: SOUTH SHIELDS, CO. DURHAM



Valves and their applications

85A1 NEON STABILISER TUBE

In the design of many types of equipment it frequently happens that a stable D.C. supply is required. To take a practical example, local oscillator drift in a F.M. receiver may necessitate frequent retuning to eliminate distortion in a narrow band discriminator. The use of temperature compensated circuits in highly stable oscillators is, of course, a necessity but the performance can be still further improved by the use of a stabilised D.C. supply.

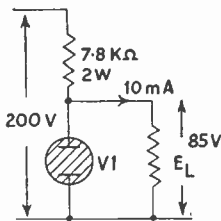

Fig. 1(a)

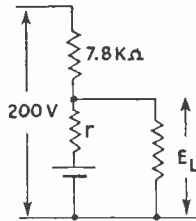

Fig. 1(b)

The simplest voltage stabilising circuit is that shown in Fig. 1(a) and its action may be explained by reference to Fig. 1(b). The stabiliser tube V1 behaves in a similar manner to a battery with a small but finite internal resistance r ; the voltage appearing across the load E_L will be the sum of the burning voltage of V1 and the voltage drop across r . With the circuit values given in Fig. 1(a), the change in E_L will not be greater than 2V for load changes between 7 and 14mA or input voltage changes between 170 and 220V.

When a very much higher degree of stability is required the circuit of Fig. 2 may be employed. Its stabilising action is as follows: (1) An increase in E_1 causes a corresponding increase in E_L . (2) A fraction of the change in E_L is fed back to the grid of V2 which causes a fall in the anode voltage of V2 and the grid of V3. (3) This increases the voltage drop across V3 and tends to keep E_L constant.

It will be seen that the function of V1 is to provide a stable reference voltage for the cathode of V2. Changes in voltage across V1 due to its internal resistance are automatically compensated by the circuit but any irregular changes in this voltage may cause considerable changes in E_L . These irregular changes in voltage stabiliser tubes arise mainly from (1) Discontinuities in the I/V characteristic and (2) Variations

in burning voltage with temperature. Provided that the 85A1 is operated with a current of at least 4.5mA no discontinuities occur in its I/V characteristic; its temperature coefficient is $-3.25\text{mV per }^\circ\text{C}$ and temperature effects will therefore be negligible in all normal applications.

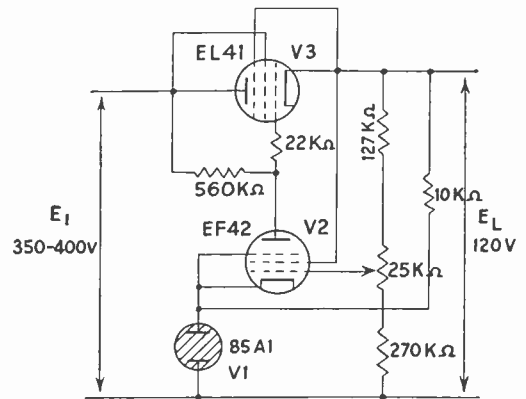

Fig. 2

With the circuit values of Fig. 2, the change in E_L for a change in E_1 of 10%, or a change in load from 0 to 40mA, will be less than 0.05V.

Characteristics of 85A1

Mean burning voltage	85V
Maximum current	8mA
Minimum current	1mA
Optimum current range	1.3 to 4.7mA
Internal resistance	290 Ohms at $I = 4.5\text{mA}$
Temperature coefficient of burning voltage	$-3.25\text{mV}/^\circ\text{C}$.



Reprints of this report from the Mullard Laboratories together with additional circuit notes can be obtained free of charge from the address below.

MULLARD ELECTRONIC PRODUCTS LTD., TECHNICAL PUBLICATIONS DEPARTMENT, CENTURY HOUSE, SHAFESBURY AVE., W.C.2

(MVM79)

Wireless World

VOL. LIV. NO. 12

DECEMBER 1948

RADIO AND ELECTRONICS

The Wireless Telegraphy Bill Establishing a New Principle

UP to the present time radio in Great Britain has been controlled by the Postmaster-General under the powers conferred on him by the Wireless Telegraphy Act of 1904. It is a high tribute to the foresight of those who drafted the Act that it has provided a workable basis for regulating such a rapidly growing art for 44 years. In strict justice, perhaps still greater tribute should be paid to the Post Office for the generally benevolent and effective manner in which it has exercised its powers. This is all the more remarkable because our legislation has been on a foundation that, to most lay minds at least, seems inherently unsure. The Act of 1904 was concerned with establishing the Postmaster-General's monopoly, rather than with the good governance of the art. In spite of that, cases of restrictive action likely to hamper development have been remarkably few, and, so far as this journal is concerned, the Post Office has generally lent a sympathetic ear to any protests we have been impelled to make.

With the passage of time the Postmaster-General has gradually assumed control of the various offshoots of wireless telegraphy. The main part of the Bill now before Parliament will merely confirm his powers.

Such things as radiolocation (in the widest sense) as well as radio control of machinery are to become, legally speaking, "wireless telegraphy."

Undoubtedly, the most important part of the Bill is the section dealing with interference. *Wireless World* has long contended that a situation where there is no legal barrier to the radiation of interference is intolerable, and we welcome the

principle that power will be given to the Post Office to prevent with force of law the use of apparatus likely to cause undue interference.

It is not intended here to discuss in detail the methods proposed for putting into effect the principle of compulsory interference suppression. Unfortunately, criticism of this part of the Bill has been largely on emotional and party-political grounds with which we are not concerned. Exception has been taken to the conferring on the P.M.G. of right of entry in the enforcement of the anti-interference clauses, but it seems to have been forgotten that for many years he has possessed a legal right of entry to homes licensed for broadcast reception—about 90 per cent of all those in the country. Other and more useful grounds of

criticism present themselves. For instance, the appointment of an advisory committee to advise the P.M.G. on such matters as permissible levels of interference may possibly cause interminable delays through failure to reach agreement. Earlier proposals for compulsory suppression have been bedevilled by delays through this cause. But that is a small matter compared with the broad principle, which will be readily conceded in all radio technical circles, that there

should be unified control of all man-made radiation, deliberate or fortuitous, within our part of the frequency spectrum. That principle is now to be established, and at last the P.M.G. will have power to give his licensees the protection to which they should be entitled. Not only radiation, but "deliberate reflection of electro-magnetic energy" up to three million Mc/s is covered.

Wireless World Overseas Issues

Starting with this issue, copies of *Wireless World* going abroad will be printed on heavier paper, and, periodically, will include extra pages. This has been made possible by a modification of Board of Trade regulations; these changes cannot apply to copies for home readers.

WITH large numbers of small ex - Govt. cathode - ray tubes available on the radio market, the home construction of oscilloscopes seems to be the vogue. While this natural desire to make oneself the owner of such an attractive and versatile instrument has much to recommend it, yet there is the serious error into which many intending constructors fall of believing that the tube itself is the be-all and the end-all of the equipment's design. This is far from the truth, for the purchase of a tube, even if it happens to be perfectly suitable for inclusion in an oscilloscope, is only the first small step towards the final aim—a well-constructed and attractive instrument that

CATHODE-RAY

General Purpose Design with Wobbulator

By S. A. KNIGHT

really will be a valuable piece of test equipment.

In the instrument to be described everything is built up from scratch. The tube employed at present is a 3-in Emiscope 4/1 (Marconi), used on visual-indication equipments (V.I.E.) in the early stages of the war, operating at 750-800 volts on the final anode. This type of tube is eminently suitable for oscilloscope

work and is preferable to many larger types now available requiring considerably higher working voltages. Any small tube (about 3-in to 4-in screen diameter), operating at about 750-1,000 volts, is, however, suitable for the present design, since the only small modifications required to the full circuit of Fig. 1 are those involving the tube supply network, and these will be fully

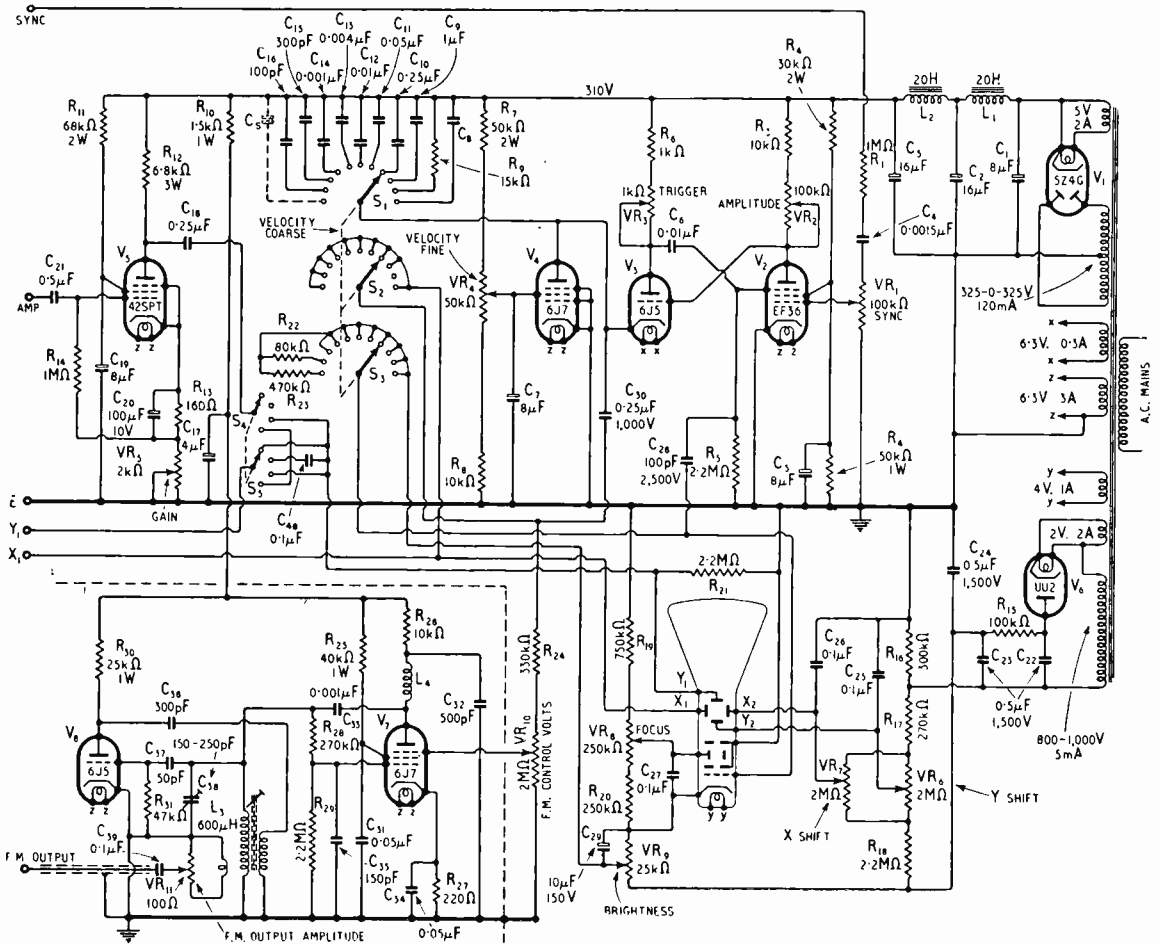

Fig. 1. The complete circuit diagram of the oscilloscope. A three-valve time base is used and a single-valve signal amplifier. The wobbulator has two valves—an oscillator and a reactor. All resistors are 1/2-watt types except those otherwise marked and variable types which should be of 3-W nominal rating. Capacitors should be generally of 450-V rating except where otherwise marked.

OSCILLOSCOPE

described later on. All other circuit details are suitable as designed, and no alterations are necessary for a change of tube.

Briefly, the complete design incorporates:

(i) a time-base circuit (3 hard

valve circuit was decided upon immediately on account of the difficulties experienced with gas dischargers on frequencies above about 25 kc/s. The time-base is built around three valves, V_2 , V_3 and V_4 and utilizes Puckle's generator circuit. It generates without difficulty a linear sweep of controllable amplitude through the frequency range

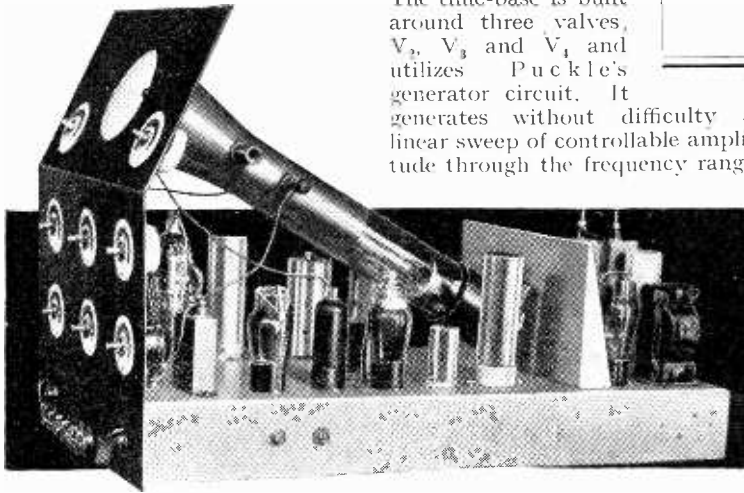

General view of the completed oscilloscope.

valves), generating a linear saw-tooth waveform of controllable amplitude and covering the frequency range 5–200,000 c/s approximately. This extremely high upper-frequency limit enables individual wave analysis and examination to be undertaken on the work source up to several megacycles per second in frequency, and is an important aspect in the design of any oscilloscope.

(ii) a single-valve amplifier for vertical deflection giving a gain of some 50 times over the frequency range 60–550,000 c/s with a useful amplification up to 2 Mc/s, thus making it suitable for work on pulsing circuits and television, a further important feature;

(iii) an entirely optional frequency-modulation circuit (2 valves), controlled by the time-base, giving a variable amplitude output of 445–480 kc/s \pm 12 kc/s, for I.F. circuit alignment on receivers employing a frequency in this band.

These individual sections will be dealt with in more detail in the following paragraphs.

In the design considerations of

5–200,000 c/s in 9 steps, each of these being continuously variable.

Referring to the circuit diagram, the time-base charging capacitor (C_9 to C_{16}) is selected by S_1 , the high-frequency contact being dependent upon the circuit strays C_s . The selected capacitor charges linearly through V_4 which is an R.F. pentode (6J7) connected as a constant-current valve, the time of charge being controllable by VR_1 feeding the screen. VR_1 is thus a fine frequency (velocity) control and permits smooth control of all sweep frequencies between the extremes set by the selection of S_1 . As the selected capacitor charges through V_4 the cathode of the triode discharger (6J5) falls towards earth, and thus approaches the voltage present upon its grid due to the drop across VR_2 and R_3 in the anode of V_2 (EF36). The extent to which this grid is held negative with respect to the H.T. line depends upon the setting of VR_2 . As soon as the cathode has fallen to the potential level of the

Time Base	Three hard valves generating continuously variable sweep frequencies, 5–200,000 c/s.
Y Amplifier	Response flat 60–550,000 c/s, 3 db down at 1 Mc/s. Useful range (with care) extending beyond 2 Mc/s. Input resistance 1 M Ω , capacitance 20 pF.
Frequency Modulator	465 kc/s \pm 12 kc/s for I.F. circuit alignment. Entirely optional attachment which can be omitted without any other alteration.

control grid, V_3 conducts and a drop is present across VR_3 which appears as a negative pulse on the suppressor of V_2 . V_2 thus swings towards cut-off, and the consequent voltage rise present at the anode carries V_3 into saturation, thus discharging the time-base capacitor through VR_3 and the valve internal resistance (both low). When the capacitor is discharged the cathode of V_3 again rises to H.T. level and the valve is non-conducting, after which the cycle repeats.

The setting of VR_3 determines the amplitude of the pulse applied to the suppressor of V_2 and should consequently be as high in value, consistent with proper working of the valve, as possible. At the same time this component is in series with the discharge path of the capacitor and cannot, therefore, be too large in value without seriously lengthening the fly-back time. With a total value of 2,000 Ω given in the present circuit a compromise setting is easily found where the lowest value consistent with good triggering action is the aim in view. For very low settings the time-base will collapse. In general, a higher value is required for the upper frequency end of the time-base range, and to avoid the 1,000- Ω preset control, a 2,000- Ω fixed resistor *may* be inserted in this anode lead.

VR_2 determines the amount by which the grid of the discharger V_3 is held negative with respect to the H.T. line and its cathode at the commencement of the charging cycle. It therefore controls the amplitude of the generated saw-tooth and enables the sweep length to be adjusted within very wide limits. The

Cathode-ray Oscilloscope—

maximum setting of this control does not, however, necessarily give the maximum length of time-base, and also, as for the action of VR_3 , very low settings of VR_2 may cause the time-base to collapse. This control is very useful as a velocity vernier since changes in its value do affect the time-base frequency slightly.

When S_1 is set to either of the two highest frequency time-base capacitors (C_{16} and C_9) a negative impulse is developed across either R_{22} or R_{23} respectively by the application of a negative pulse from the suppressor of V_2 during the fly-back period, via C_{28} , which momentarily reduces the tube brilliance during the return trace. Similarly, there is some brightening effect during the forward sweep on these switch positions when the suppressor of V_2 swings positive, and the brilliancy of the trace thus tends to constancy as the spot velocity increases up to the maximum frequency of some 200 kc/s. On these latter two switch positions the brightness control (VR_9) has very little effect on spot brilliancy. It will be noticed, also, that on the 2nd position of S_1 (reading anticlockwise on the diagram) the charging capacitor is replaced by a resistance ($R_9 = 15 \text{ k}\Omega$). On this position the time-base becomes inoperative and the X_1 plate of the tube is released by S_2 from the time-base circuit. Only the spot then appears on the screen, a useful point for certain D.C. and amplitude test work. Since the X_1 plate is completely 'floating' in this position, a high-resistance D.C. path must be provided for it to return to earth or inaccuracies will result due to spot drift. A suitable value is 2 M Ω . An external time-base may, of course, be applied at this switch setting, through X_1 terminal.

Synchronizing

The time-base sweep may be synchronized to the work input by simply connecting the SYNC terminal to the Y_1 input. This has an input impedance sufficiently high to have no effect on the work voltage source and is isolated from the time-base circuit proper by its connection to the control grid of V_2 through the Sync control

VR_1 . Normally, this control should always be set fully anticlockwise (slider to earth), and for effective synchronizing should only be advanced as little as possible consistent with effective locking. Too much of this control will destroy linearity of the trace and produce excessive X distortion. When using the amplifier

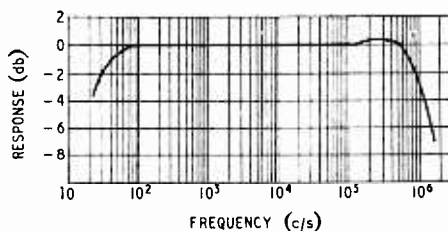

Fig. 2. Frequency response curve of the signal amplifier.

it is essential that the SYNC terminal be connected to the Y_1 terminal and *not* to the AMP input.

The amplifier used in this circuit is a single-valve stage designed as for television video-frequency amplification with an eye to frequency response rather than high gain. To be of any real value an oscilloscope amplifier should give substantially level amplification over the range 50 to 500,000 c/s with a useful range up to at least 1 Mc/s. The present stage adequately fulfils these conditions by making use of a high-slope power pentode (42SPT), and a gain of some 50 times is obtained over the above mentioned frequency range. At first, various types of R.F. pentode such as the SP61 and EF50 were tried in this position without a great deal of success, and finally the power pentode was employed in order to obtain the voltage swing required without distortion.

The problem of gain control necessitated something better than the ordinary grid potentiometer. With this latter system the input impedance of the stage is different at different settings of the control and for very low settings the input capacitance of the valve offers a serious shorting effect to high frequencies. The only useful method of overcoming this is to employ a tapped input potentiometer with a small capacitor connected permanently across the upper half to compensate for the valve capacitance. This circuit was tried out, using

a normal potentiometer with a suitable capacitor from the slider to the hot terminal, but the H.F. response suffered on account of the cumulative error in the correction as the slider approached earth. In the end, on account of the complication of a tapped input potentiometer, the whole system was scrapped in favour of a feedback control such as is used on some commercial amplifiers.

This circuit makes use of the current in the bias control VR_5 to de-

velop a feedback voltage and thus vary the gain of the stage. This feedback system of control tends to stabilize the output current rather than the output voltage developed and there is thus a tendency for a sharp falling off in response at high and low frequencies for a constant alternating current in the anode load. This form of feedback, considered as such, therefore, does little to improve the frequency response of the amplifier (though there is some improvement at low gain), but it tends to minimize amplitude distortion and it does away with the evils of the input potentiometer. A further important point in connection with this form of control is that of the input resistance which is virtually constant throughout the range of gain control setting, and any tendency to phase distortion at low frequencies is minimized by working at a deliberately reduced level. In actual use, this form of gain control is apt to appear 'rough'; that is, the trace is liable to jump violently while the control is actually being rotated. This is not a fault, however, and once set, the trace is perfectly stable.

Some experiments were conducted with inductance compensation in the anode circuit to improve the H.F. response of the amplifier, but with little effect. As it stands the response is substantially flat from 60 to 550,000 c/s with a drop of 3 db at 1 Mc/s. Considerable gain remains up to

2 Mc/s, making the amplifier useful even at this frequency. The response curve of Fig. 2 was taken at half gain and for smaller settings there is some improvement in both the high- and low-frequency response, a useful point to bear in mind when using the amplifier.

Tube Circuit and Controls

Little explanation is needed for the tube circuit and controls as they stand in the present design, but there are several points worthy of attention with regard to possible modification of this part of the circuit to utilize a different make of tube. Since this is the only section requiring alteration on this account, some little space will be given to the problem.

Referring to the main circuit, the actual tube network from

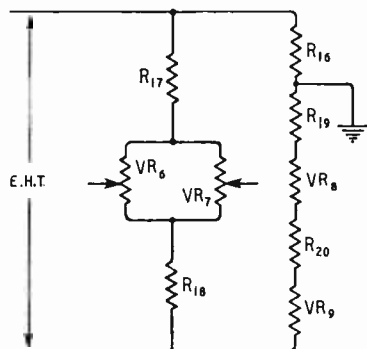

Fig. 3. The tube voltage-supply network, which may need alteration with different tubes, is shown here.

which Brightness and Focus control is obtained, consists of R_{19} , VR_8 , R_{20} and VR_9 in series between earth (final anode) and the negative pole of the E.H.T. rectified by V_6 and smoothed by C_{22} and C_{23} and R_{15} in the conventional way. The positive pole of this supply is itself returned to earth through R_{16} which is of such a value (300 kΩ) in proportion to the sum of R_{19} , VR_8 , R_{20} and VR_9 all in series (1,275 kΩ) that a drop of approximately 1/5th of the total available voltage on C_{23} is developed across it. This voltage is used for the purpose of applying shift potentials to the X_2 and Y_2 plates. From the simple diagram

of Fig. 3 it will be seen that the X and Y Shift controls are paralleled (VR_7 , VR_8) and are in series with R_{17} and R_{18} across the total E.H.T. supply. By the choice of suitable values of R_{17} and R_{18} it is possible to ensure that the control sliders pass through earth from a positive to a negative potential (or vice versa), and hence the potential of the deflectors can be varied above or below that present upon the X_1 or Y_1 . In the present design, which will probably be suitable for most 3-in to 4-in tubes requiring 750-1,000 volts H.T. values are calculated on the basis that the current through both networks, including beam current, is so small that voltages developed are proportional to the resistance values. Hence, taking E.H.T. across C_{23} to be 1,000 volts, the voltage across R_{16}

$$= \frac{R_{16} \times 1000}{R_{16} + R_{19} + VR_8 + R_{20} + VR_9} = \frac{300 \times 1000}{1575} = 200 \text{ V approx.}$$

leaving a total of 800 volts on the tube anode. The shift sliders now have to pass through earth approximately at the centres of their travel, therefore, from Fig. 4—

$R_b : R_c :: 1 : 4$ or $R_c = 4R_b$. Bearing in mind the necessity for keeping the total current down to a minimum, a suitable total value for $R_b + R_c$ is 3.5 MΩ, whence $R_b = 0.7$ MΩ and $R_c = 2.8$ MΩ. But each resistance includes 0.5 MΩ of the joint shift potentiometers resistance, assuming the sliders to be central, and both at earth, and so final suitable values for R_{17} and R_{18} are 270 kΩ and 2.2 MΩ respectively.

The smoothing capacitors C_{22} , C_{23} and C_{24} are not critical in value and those indicated in the table are perfectly adequate. The only point requiring attention is that of working voltage which must be adequate for the voltage applied, itself depending upon the tube used.

This two-valve circuit was included in the design simply to extend the range of usefulness of the instrument without increasing the number of panel controls which already numbered ten. Some readers may wish to omit this part of the circuit entirely, and this is easily accomplished

by the simple procedure of replacing R_{24} and VR_{10} by a single 2.2 MΩ resistor.

The circuit is designed to cover only the 465-kc/s I.F. band, and throughout this range 'wobulation' is effected over a range of about ± 12 kc/s on either side of resonance. The circuit is very simple and consists of a tuned-grid oscillator, back coupled from the anode through C_{36} and a coupling coil, and a variable-reactance valve V_7 (6J7) is connected across the tuned circuit C_{38} and L_3 . The important components in this part of the circuit are R_{28} and C_{35} ; these are connected in series across the triode tuned circuit, their junction being returned to the control grid of V_7 . C_{33} is simply a blocking capacitor and R_{29} provides grid circuit continuity. The value of R_{28} is 0.27 MΩ and is consequently very high compared with the reactance of C_{35} (150 pF) at frequencies around 465 kc/s. Hence, when the oscillator is functioning the current through R_{28} and C_{35} is very nearly in phase with the oscillator voltage, and the voltage on the control grid of V_7 , developed across C_{35} , is 90° lagging on the oscillator voltage. The valve anode current is in phase with the grid voltage and is consequently lagging 90° on the oscillator voltage. From the point of view of the oscillator, therefore, V_7 and its associated components draw a lagging current and hence behave as an inductance. This 'inductance' is in parallel with the oscillator tuned circuit and thus modifies the tuning of the latter by an amount depending upon the value of the

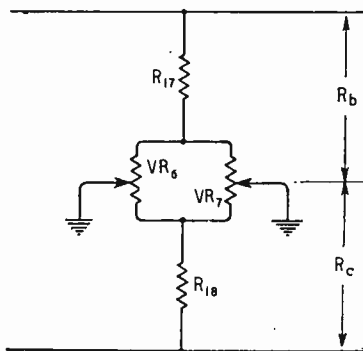

Fig. 4. This diagram is used in computing the values for the shift network.

Cathode-ray Oscilloscope—

former. This value is adjustable by the amount the slope (g_m) of the valve is adjustable, and is given by $C_{35} \cdot R_{28} / g_m$ for a particular value of g_m .

Control voltage is applied to the suppressor grid of V_7 from the time-base saw-tooth supply and modifies the slope of the valve by an amount dependent upon the setting of VR_{10} . The slider of this control falls from a positive value to earth during the charging cycle of the time-base and hence changes g_m from a large to a small value as the charge proceeds. Since the spot on the screen is moving across the screen during this period, its position at any instant is a function of the slope of the valve and hence the frequency generated by V_8 .

The output from the frequency modulator is adjustable by the setting of VR_{11} , and is normally applied, through a low-capacitance screened line, to the I.F. or F.C. valve in the receiver under test. This receiver output is generally best taken directly from the diode load through the oscilloscope amplifier which has an adequate response to cope with the frequencies concerned. The correct setting of VR_{10} to 'fit' the receiver I.F. response curve on to the screen (i.e., to give the correct amount of frequency change) is quickly found in practice (it is fairly high up VR_{10}), and the trace can be centred by adjustment of the core of L_3 . The setting of VR_{11} and the Amp. Gain can be set to give the best amplitude of the image. As the frequency modulation and the horizontal sweep of the spot are both controlled from the time-base, synchronism is automatic and a steady response curve is readily obtained. It is best, however, to lock the time-base to the mains frequency to avoid any possibilities of hum pick-up affecting the trace and this is best done by choosing the lowest time-base speed (capacitor C_9 position of S_1) and adjusting the velocity control VR_4 to give a steady image. The actual time-base frequency is fairly important and it cannot be high (a maximum limit is 100 c/s) without the possibility of distorting the trace. Capacitor C_8 (2 μ F) is specially included in the circuit diagram to allow a very

slow sweep to be obtained from the time-base if required, but in general it is not needed and this switch contact may be connected across to the C_9 contact or ignored altogether.

Construction

The photograph shows a general view of the complete instrument, the nearest valves being the time-base components. The amplifier and the frequency-modulator valves are on the far side, and the whole power unit is behind the dividing screen at the rear. This layout, together with careful screening below chassis, gives a trace free from hum troubles, though a mu-metal tube screen may be included if one is available.

A mains transformer with all windings may be difficult to obtain and two separate items may, of course, be employed. Particularly note that the 42SPT is a 4-volt valve and is run from the 6-volt heater winding. A series resistance of about 1 Ω is included in its heater path and is not shown in Fig. 1; this is best found experimentally.

Other points to note are: C_{29} should not be metal cased, or if it is the case must be insulated from earth; the spindles of VR_8 and VR_9 should be insulated from chassis as an extra precaution against breakdown. Switches S_4 and S_5 are ganged and select the inputs: (a) D.C. to Y_1 —position shown in the diagram, (b) A.C. to Y_1 , (c) Amplifier to Y_1 plate, and amplifier output available at Y_1 terminal, (d) Amplifier available at Y_1 terminal freed from internal circuits.

APPENDIX*Frequency Modulator*

Oscillator tuning capacitance = 200 pF, and therefore the effective L for 455 and 475 kc/s (assuming a 20-kc/s swing) is 605 μ H and 555 μ H respectively. This effective L is made up of L_3 and the reactor valve V_2 (L_2) in parallel, and L_2 is variable by the amount g_m is variable. If g_m varies from 0.5×10^{-3} A/volt to 2×10^{-3} A/volt, then the larger value becomes 20.5 mH, whence L_3 must be 625 μ H. Hence for $g_m = 2 \times 10^{-3}$ A/volt

$C_{35} R_{28} = 41 \times 10^{-6}$
so that making $R_{28} = 0.27$ M Ω , $C_{35} = 150 \times 10^{-12}$ F = 150 pF.

"NUCLEONIC" EQUIPMENT

MANY of the electronic measuring instruments associated with Government research in nuclear physics were developed by the Ministry of Supply in conjunction with Dynatron Radio, of Maidenhead, who are now free to offer these products to approved research organizations.

The use of radioactive tracer elements in medicine is well known, and the technique is being applied in industry to the investigation of

the ionization of the gas forming the dielectric between polarized electrodes in a sealed glass tube. The rate of production of pulses is a measure of the radioactivity, and electronic counters (scalers) have been devised for this purpose.

In the Dynatron Type SC.200 scaling unit, indications up to 100 are given by a series of miniature neon lights, and multiples of 100 up to 1,000,000 by a Post Office relay counter. The instrument oper-

ates with a pulse separation of 6 microseconds or, alternatively, with a "paralysis" time up to 1 millisecond.

Auxiliary equipment includes a probe unit (Type PR200), stabilized power unit (Type P200) and a test oscilloscope monitor (Type M.200).

Dynatron Type 200 scaling unit for counting ionization pulses.



chemical and metallurgical problems. For the detection of radioactivity the most sensitive device is the Geiger-Muller counter which produces pulses of current, due to

Cabinet racks for housing these and similar units, made to the Post Office standard panel width of 19 inches, are available in heights of 3, 4 and 6ft.

CIRCUIT SYMBOLS

Notes on the New British Standard

By L. H. BAINBRIDGE-BELL

(Royal Naval Scientific Service)

THE appearance of a revision of "Graphical Symbols for Telecommunications"* (briefly recorded in last month's *Wireless World*) after a lapse of eleven years will be welcomed particularly by workers in the short-wave and microwave techniques and in the complicated circuits which have made such strides during this interval.

The book deals with symbols for "block schematics" and plans as well as the type of graphical symbol for use in circuit diagrams with which we are here concerned. A circuit diagram is defined as: "a diagram which depicts in simple form, by means of symbols, the essential components and the interconnections required to provide the information necessary to show the operation of the circuit. A circuit diagram will usually be drawn so as to show this as clearly as possible and therefore will not necessarily depict the various items and their connections in their actual spatial relationship."

The last sentence should be a warning to those who spoil a circuit diagram by trying to combine it with a layout drawing and end by producing something which is suitable for neither purpose.

Guiding Principles



The pages dealing with "Guiding principles to be observed in using the symbols and in preparing diagrams" are, in the writer's opinion, the most important additions. To borrow a term from Frederick Bodmer's "The Loom of Language" they might well be called the "table-manners" of circuit drawing. The following "principles" are selected in order to give an idea of the field covered.

* B.S. 530; British Standards Institution, 28, Victoria Street, London, S.W.1. 10s 6d, post free.

"Diagrams should be drawn so that the main sequence of cause to effect goes from left to right, and from top to bottom." (The writer would prefer "or from top to bottom.") "When this is impracticable, the direction should be shown by an arrow."

"Frequently occurring groups of symbols should be drawn in standard recognized forms." The groups shown include multivibrators, rectifier circuits, filter-network and bridges.

The applications of these principles are illustrated in two of the diagrams at the end of the book. It should be emphasized that these two diagrams are *not* intended as examples of complete drawings, but are intended only for the above purpose. With this end in view, they have been distorted so as to include as many "principles" as possible. The diagrams referred to are: page 88 "Modulator and Master Oscillator" and page 89 "Oscilloscope."

On page 8 we read "Of wires meeting at a connecting point, not more than two should be collinear. They should be drawn thus  and not thus 

." The writer considers that the observance of these "Staggered cross-roads" would contribute more than any other rule to the avoidance of "accidents" in the shape of mistakes in drawing or in careless tracing. He would respectfully draw the attention of the *Wireless World* drawing office to this rule, which has had a rather unnoticed existence in this British Standard for fourteen years.

Before leaving these pages one other recommendation (on page 15) is worthy of mention. We read "It is frequently necessary to locate [why not "find"??] in a circuit diagram . . . some particular component . . . by the

In radio, the circuit diagram is something more than a convenient graphical representation of electrical connections. As "Cathode Ray" points out on p. 459 of this issue, it is to most of us an indispensable aid to thought. The choice of symbols used in such diagrams is thus of importance, and so the recent appearance of a revised book of standardized symbols is a matter of some interest.

coded reference only. One method of facilitating such location is illustrated below. This indication extends along the length of a diagram." [See also diagrams on pp. 88, 89 of the book.]

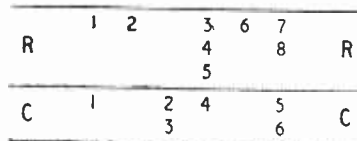

The writer believes that this system was invented by the Royal Air Force. With the increasing complicity of apparatus, this aid is becoming more and more necessary.

Too Many Symbols?

There are shown nearly three hundred circuit symbols. The writer often hears the opinion expressed that there are far too many symbols, and that there is an unwise tendency to distinguish by different symbols the differing method of construction or differing materials of devices which perform the same electrical operation (for example, different types of transformer cores) and also to indicate mechanical details (for example, direction of rotation of control knobs).

In defence of this large number of symbols, the writer produces the following arguments:—

(1) Many of the 300 are variants of about 100 basic symbols and illustrations of combinations of these. For example, No. 25 (resistor) plus No. 20 (sliding control) gives No. 25.11 (potential divider, variable).

Circuit Symbols—

(2) If all technical manuals contained diagrams showing mechanical details in addition to the essential circuit diagram, many of these extra symbols would be unnecessary. Often only one diagram (the circuit diagram) is provided; this, then, is the only place where these apparently irrelevant details can be shown.

(3) The writer is constantly being asked by rather unimaginative people, who have perused the nine symbols for valve elements (grid, anode, etc.) and the twenty examples of their combinations (diode, pentode, etc.). "How do you draw, say, a double-diode octode?" The 200 variants are useful to such people.

Criticism would be disarmed if B.S.I. or some other body were to produce "Basic Circuit Symbols"—much as the B.S.I. has produced a card containing extracts from its standard on proof-correcting.

The adjoining symbols, which have not appeared in previous editions, are worthy of attention.

The above review has tried to show that an important new aid to standardization and interpretation has been produced; it should find its way into the hands of those who want their diagrams to "be understood of the people." Readers who have been (or are still) in the fighting services may be glad to know that items which

Birmingham.—On December 10th members of the Slade Radio Society will be given demonstrations of home recording by D. O'C. Roe, of Birmingham Sound Reproducers. Meetings are held fortnightly at 8.0 at the Parochial Hall, Slade Road, Erdington. Sec.: C. N. Smart, 110, Woolmore Road, Birmingham, 23

Croydon.—The normal monthly meeting of the Surrey Radio Contact Club will not be held in December as the club's annual social gathering has been fixed for December 14th at the Purley Hall, Banstead Road, Purley. The next meeting will be on January 11th at 7.30 at the "Blacksmith's Arms," Southend, Croydon. Sec.: L. C. Blanchard, 122, St. Andrew's Road, Coulsdon, Surrey.

Derby.—A series of television lectures is being given to members of the Derby and District Amateur Radio Society which meets on alternate Wednesdays at 67B, London Road, Derby. Sec.: F. C. Ward, G2CVV, 5, Uplands Avenue, Littleover, Derby.

Edinburgh.—Meetings of the Lothians Radio Society are held on the last Thursday in each month at 7.30 in the

NEW SYMBOLS

No. 4.1.

Crossing of conductors without connection:

The bridge  is included as an alternative but it is associated with a note "The bridge is deprecated unless considered essential." The writer hopes that *Wireless World* will continue to consider it "essential" in the type of circuit which it illustrates so clearly.*

No. 19.1.

Pre-set adjustment 

No. 25.4.

Thermistor 

(the full disc indicates a negative resistance temperature characteristic; positive characteristic is indicated by an open circle.)

No. 43.

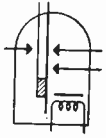
Vibrator as used for power supply 

No. 79.6.

Secondary emission electrode 

No. 94.

Magnetron: concentric line output 

(this symbol was devised when the insides of a magnetron were still "secret.")

No. 95.

Vision pick-up tube: storage type (Iconoscope) 

No. 801.41.

Adcock aerial 

No. 801.5.
Rhombic aerial 

* *Wireless World* drawing office says "Mr. Bainbridge-Bell's approval of our practice in the matter of bridge cross-overs seems to cancel out his disapproval of our use of col-linear connections (see previous page). When bridges are used, the risk of errors through this cause automatically disappears."—Ed.

are common to B.S. 530 and to the "Services" book (B.R. 1079—Tels. A. 301—A.P. 2867 to give the Navy, Army and Air Force references) are represented by the

same symbols in the two publications, except for trivial differences a satisfactory example of combined operations between the services and industry.

NEWS FROM THE CLUBS

Chamber of Commerce Rooms, Charlotte Square, Edinburgh. Sec.: I. Mackenzie, 41, Easter Drylaw Drive, Edinburgh, 4.

Enfield.—It has been decided to restart the Enfield Radio Society and the inaugural meeting will be held on January 12th at 8.0 at the King's Head Hotel, Enfield Town. Acting Sec.: B. C. Loring, G2FDO, 98, Myddleton Road, Hornsey, London, N.8.

Harrow.—Members of the Radio Society of Harrow will compete for the Club Constructors' Challenge Cup on December 7th. The Club's transmitter is now licensed under the call G3EFX and will soon be operating on all bands from 10 to 80 metres. Sec.: J. R. Pikett, 93, Whitmore Road, Harrow, Middx.

Liverpool.—The November programme of the Liverpool and District S.W. Club includes a lecture demonstration on capacitor testing by H. B. Morgan, chief engineer of Wingrove and Rogers. Meetings are held on Tuesdays at 7.30 in St. Barnabas Hall,

Penny Lane, Liverpool, 15. Sec.: W. G. Andrews, G3DVV, 17, Lingfield Road, Broadgreen, Liverpool, 14.

Southall.—The West Middlesex Amateur Radio Club has been unable to find a suitable building for a club-room and workshop and has, therefore, started a fund for the purchase of a hut. Meetings continue to be held at the Labour Hall, Uxbridge Road, Southall, on the second and fourth Wednesdays of each month at 7.30. Sec.: C. Alabaster, 34, Lothian Avenue, Hayes, Middx.

Southend.—At the meeting of the Southend and District Radio Society at 7.45 on December 10th in the Municipal College, Victoria Circus, R. Ritchie, of E. K. Cole, will speak on pulse modulation. Sec.: J. H. Barance, M.B.E., 49, Swanage Road, Southend-on-Sea, Essex.

Walworth.—Meetings of the Walworth (Men's Institute) Radio Club have restarted on Wednesdays and Fridays at 7.0 at the Avenue School, John Ruskin Street, London, S.E.5. Sec.: B. E. Symons, 100, East Dulwich Grove, London, S.E.22.

TELEVISION WAVEFORMS

Some Comparisons Between British and American Standards

ALL television systems now in use have a fundamental likeness in spite of a number of surface dissimilarities. The number of scanning lines used may vary and the synchronizing signals may be somewhat different in form; some systems may use positive modulation and others negative, while again vertical polarization of the radiated wave may be adopted in some cases and horizontal in others.

Through all these minor differences the broad principles of line scanning, interlacing, and synchronization by pulses transmitted as 'blacker than black' signals remain the same in all systems. Some of the differences are not always well understood, with the result that unjustifiable

carrier. In America negative modulation is used; with this the tips of the sync pulses correspond to the full carrier amplitude, black to 75 per cent of the full amplitude and white to 15 per cent. In both systems the duration of a line sync pulse is 10 per cent of the full line period.

Because the peak power with negative modulation is radiated for only 10 per cent of the time as compared with 85 per cent for positive modulation with a white picture, the ratio of peak/mean powers is greater with it. This is often claimed to mean that higher power can be obtained from the same transmitter output valve with negative modulation than with positive. This is not necessarily true, however.

and the next the relative instantaneous power output. The relative instantaneous anode power dissipation is then calculated on the assumption that the efficiency is constant at 50 per cent, and that the grid power dissipation is proportional to the fourth power of the carrier amplitude.

The line 'Occupance' shows the fraction of time allotted to each quantity and is used in computing the relative average powers given in the three following lines. The appropriate figures are then summed to give the total relative average powers.

Since the changes of carrier amplitude between black and white are not the same in the two systems, this must be taken into

	White		Black		Sync		Modulation		
	+	-	+	-	+	-	+	-	
Relative Carrier Amplitude ...	1.0	0.15	0.3	0.75	0	1.0	Total Relative Average Power		
Relative Instantaneous Power									
Output ...	1.0	0.022	0.09	0.562	0	1.0	Output W_a ...	0.855	0.606
Anode Dissipation ...	1.0	0.27	0.5	0.94	0	1.0	Anode Dissipation D_a ...	0.875	0.945
Grid Dissipation ...	1.0	0	0	0.32	0	1.0	Grid Dissipation G_a ...	0.85	0.39
Occupance ...	0.85	0	0.05	0.9	0.1	0.1	Relative Peak Power W_m ...	1.0	1.0
Relative Average Power									
Output ...	0.85	0	0.005	0.506	0	0.1	Useful Picture Signal (= change from black to white)	0.7	0.6
Anode Dissipation ...	0.85	0	0.025	0.845	0	0.1	Figures of Merit		
Grid Dissipation ...	0.85	0	0	0.29	0	0.1	$E_u/\sqrt{W_m}$...	0.7	0.6
							$E_u/\sqrt{W_a}$...	0.76	0.77
							$E_u/\sqrt{D_a}$...	0.75	0.62
							$E_u/\sqrt{G_a}$...	0.76	0.96

claims are not infrequently made by their supporters. As will appear later, it turns out in some cases, at least, that there is very little to choose between the alternatives on technical grounds. This being so, it is unfortunate that one or other of the alternatives has not been universally adopted.

Two of these points of difference only will be discussed here, the sense of modulation and the inclusion, or otherwise, of equalizing pulses in the synchronizing signals. In Britain, positive modulation has been adopted with peak-white corresponding to full carrier amplitude, black to 30 per cent of full amplitude and the tips of the synchronizing pulses to zero

The matter is not as simple as it seems at first sight, however, and in a recent paper L. H. Bedford¹ has analysed the position in some detail. He compares the two systems under the highest mean power conditions for each; these are the transmission of a white picture with positive modulation and a black picture with negative. The results are summarized in the Table above which may need a little explanation.

In each column the left-hand set of figures refers to positive modulation and the right-hand to negative. The first line gives the relative carrier amplitudes for the three different signal conditions,

account and is represented in the table by E_u . The figures of merit for the two systems are then computed as the ratios of E_u to the square roots of the various powers.

When peak power is the limitation positive modulation is superior in the ratio $0.7/0.6 = 1.16$; it is also better when the limit is set by anode dissipation and in the ratio $0.75/0.62 = 1.2$. However, when grid dissipation forms the limit negative modulation is superior and the difference is then rather greater, the ratio being $0.96/0.76 = 1.26$.

The greatest difference between the two systems is no more than 2db, and occurs with negative

modulation in the rather unlikely event of grid dissipation being a limiting factor. In the more likely event of anode dissipation providing the limit the advantage is with positive modulation but only to a little less than 1.5 db.

Interference

The differences between the two systems affect matters much more at the receiver. In the paper already referred to Bedford¹ has pointed out that there are three main differences to be considered—the effects of ignition interference of greater peak amplitude than the full carrier on the picture and on the synchronizing, and the possibilities of A.G.C.

Ignition interference causes white spots on the picture with positive modulation but black spots with negative. With a simple limiter circuit the spots can be prevented from spreading in the former case and there is little to choose between the two systems. The advantage does lie with negative modulation, however, as it needs no limiter.

Matters are very different when the effect of interference on synchronizing is considered. With negative modulation a large interference peak may trip the line time base at any time and cause 'tearing of lines,' but with positive modulation it cannot produce false sync signals and can affect the synchronizing only by obliterating a genuine sync pulse. It can do this only when an interference peak coincides with the leading edge of a sync pulse.

This is quite a big point in favour of positive modulation, and it is worth noting that in America it has become necessary to adopt 'flywheel sync' circuits whereas they have not been adopted in any British commercial receiver to date.

The problem of A.G.C. is not an easy one in television in spite of the claims made for negative modulation in connection with it. It has never been considered as important in Britain as in the U.S.A., probably because the provision of a number of alternative programmes was considered from the outset in that country.

The simple A.G.C. system originally envisaged for use with negative modulation has proved

rather a failure, for it is affected by interference. As a result, the use of A.G.C. has been abandoned in most American receivers. With both methods of modulation it is necessary to adopt 'strobing' if a satisfactory A.G.C. system is to be secured. Nevertheless, there is probably still some advantage in negative modulation.

One practical point which is not mentioned in Bedford's paper is that with negative modulation it is hardly practicable to use direct coupling between detector and V.F. stage and between the V.F. stage and the C.R. tube, as is the almost universal British practice. Since 15 per cent carrier level corresponds to peak white the cessation of a signal will send the tube into the 'whiter than white' region, and it will be underbiased. With positive modulation black level corresponds to 30 per cent modulation, and the cessation of the signal only drives the tube into 'blacker than black' beyond cut-off and does no harm. Because of this it is usual in American sets to use A.C. couplings with D.C. restoration. This means slightly more equipment.

Equalizing Pulses

On balance it will be seen that there is not a great deal of difference between the two systems. The advantage would seem to lie generally with positive modulation because synchronizing is less affected by interference and direct coupling can be used with some simplification of the receiver. This outbalances the need for a limiter.

Turning now to the synchronizing waveforms, British and American practice is very similar. Both adopt the elegant concept of odd-line interlacing with a frame signal slotted at twice the line frequency. The only significant difference lies in the provision of equalizing pulses before and after the frame pulses in the American system.

When an integrator is used for separating the frame pulses there is an error in interlacing. Bedford works out the timing error as

$$\frac{\delta t_1}{T} = \frac{t_s}{t_1} e^{(t_s - t_1)/2T} \frac{1 - e^{-t_1/2T}}{1 - e^{-t_1/T}}$$

where

δt_1 = timing error of the frame time base firing point

T = integrating time constant
 t_s = duration of line sync pulse
 t_1 = duration of whole line

The error can be as great as 20 per cent of the line period when reasonable values of the integrating time constant are used, and this is sufficient to cause severe pairing.

When equalizing pulses are used, however, the error is reduced by the factor $e^{-t_s/T}$ where t_s is the interval between the first equalizing and the first frame pulses. This is a considerable reduction.

It is, however, quite easy to secure a much better performance still and without the use of equalizing pulses, by adopting an alternative to integration. One method due to H. A. Fairhurst² depends on passing the wave through a suitably short time constant circuit which gives a partial differentiation. This makes the trailing edge of the first frame pulse stand out so that it is separable by a limiter and can be used for synchronizing.

This method gives as sharp an edge to the pulse as in the case of the line pulses, and so leads to very precise synchronizing. However, even perfect precision does not necessarily result in perfect interlacing because only the firing point of the time base is controlled. Careful design is needed to secure perfect interlace, but as long as there are sufficient frame pulses to cover the whole firing time of the frame saw-tooth generator, the presence or absence of equalizing pulses has no bearing on it.

It will thus be seen that while equalizing pulses are beneficial when frame pulse separation by an integrator is adopted, they are unnecessary when other methods are used, and these other methods are usually advisable for an accurate interlace.

¹ "Comparison of British and American Television Standards", by L. H. Bedford (Marconi's W. T. Company) International Television Convention, Zurich. To be published in a special edition of the *Bulletin de l'Association Suisse des Electriciens*.

² *J. Instn Elect. Engrs*, December 1938, Vol. 83, p. 797.

See also *Journal of the Television Society*, December 1937; "Interlacing," by W. T. Cocking, *Wireless World*, April 1947, p. 124, and "Television Receiving Equipment," by W. T. Cocking (2nd Ed.), p. 268.

AERIAL CORONA INTERFERENCE

Its Cause and Cure

By **F. R. W. STRAFFORD**, A.M.I.E.E. (Technical Manager, Belling & Lee)

THE increasing use of vertical rod-type aerials for broadcast and television reception has made evident a particularly troublesome form of interference which, although sporadic, is usually of very great intensity.

The experience gained by the writer's observations over the last twelve months, with the help of observers' reports, has resulted in the adoption of a device which will effect a permanent cure in the majority of cases. The few cases in which complete suppression is not realized can be explained, and the further steps required to complete the cure are outlined.

It has been customary to refer to the form of interference to be discussed as "precipitation static," and it is believed that the term was originally used to describe atmospheric electricity phenomena in connection with operational aircraft.¹

It is well known that when aircraft fly through water vapour, sleet, or snow carrying electrical charges, these charges are precipitated upon the surface of the aircraft so that it gradually attains a potential and ultimately causes corona (brush) discharges from the most exposed tips. Such discharges will naturally radiate electromagnetic impulses and, as with all discontinuous electrical phenomena, will interfere with radio reception.

Since it requires a discontinuous electric current to create an electromagnetic wave the use of the word static is hardly the correct label to attach to the phenomenon.

There would now appear to be at least two phenomena, associ-

ated with atmospheric electricity, which can disturb radio reception. First, there are atmospherics due to the radiation of electromagnetic energy from the electric discharge from cloud to cloud or to earth, visible as lightning.

Secondly, there is the interference radiated (or conducted) when conductive objects are caused to corona (brush discharge) when they are situated in a sufficiently intense electric field created by atmospheric conditions.

It is this second form of interference which is amenable to treatment and cure, and it is proposed to refer to it here as aerial corona interference.

Nature of Interference

The conditions necessary to produce this interference are invariably those obtaining in thundery weather. There are usually heavy and low rain clouds accompanied generally by heavy and sudden showers of rain, sleet or hail. There may be no thunder or normal lightning discharge atmospherics at the time. The interference usually commences abruptly with a series of slow clicks rising in repetition frequency to a few hundred per second. Sometimes the frequency is much higher and musical or squealing effects are produced. A burst of such interference can last between a few seconds and as many minutes and usually ceases as abruptly as it commences. If lightning discharges are occurring substantially overhead the burst will cease at the instant of the discharge, due to the sudden reduction of the electric intensity in the vicinity of the aerial.

It is not the intention of this article to consider in any detail the physics of atmospheric electricity, for we are concerned only

with one of the annoying effects it can produce, but briefly it must be realized that, in perfectly clear weather, an electric field exists in the atmosphere. This field, which is perpendicular to the earth, attains a maximum of about 1 volt/cm at the earth's surface, falling off with increasing height to negligible value in the tropospheric region.

During a thunderstorm, or under thundery conditions, the intensity of the field (usually reversed in polarity) increases a hundredfold or more.

The voltage gradient which will exist at the tip of an aerial will depend, apart from its position in the electric field, upon the sharpness of the tip. The gradient reduces as the tip is made blunter and rounder, and continues to reduce if a conductive sphere is fitted to it, the reduction increasing with diameter of the sphere. Irrespective of the size or shape of the aerial tip there may, at times, exist a sufficiently intense field to provide gradients at the surface of the aerial capable of causing electrical breakdown of the air which initiates the corona discharge and the intense radio interference which accompanies it.

Vertical Rod Aerials

Naturally the more elevated and "spiky" the aerial becomes the greater the voltage gradient at its tip. It is for this reason that the more extensive use of chimney-mounted rod-type aerials has been followed by more widespread complaints of corona interference.

It is not necessary for the listener's aerial to corona in order to observe the interference. Neighbouring objects, particularly lightning arrestors or nearby rod-type aerials, may be in a state of

¹ Army-Navy Precipitation Static Project, Part 4; *Proc. I.R.E.*, May, 1946, pp. 234-240.

Aerial Corona Interference—

corona and radiate their interference to the listener's aerial.

Observations on this aspect of the problem have proved that the radiated interference from an 18-ft vertical spike aerial located approximately ten feet from, and at the same height as, an identical receiving aerial produced an interfering level at least one hundred times lower than when the receiving aerial was itself in a state of corona.

The reader may justifiably ask how such an experiment was carried out in view of the identical character and elevation of the two aerials.

It should be stated that the tip of the receiving aerial was, in the first place, fitted with a spherical conductive ball of approximately 2 inches diameter. During the test the gradients at the aerial tips were such that the unprotected aerial was just in a state of corona so that the protected receiving aerial was below the corona threshold.

The sphere was then removed quickly and the increased level of interference observed. Several observations were made in all.

It can be stated with moderate assurance that re-radiated corona interference is not likely to be very serious, and at the worst can be reduced to negligible proportions by removing the aerial from the more likely neighbouring sources of corona.

So far as corona at the tip of the receiving aerial is concerned it does not require much thought to appreciate the intensity of the interference caused by the passage of the impulsive corona current through the input impedance of the receiver. It is quite usual for a broadcast signal of 100 mV/m to be rendered unintelligible by this form of interference.

Partial Cure

The fitting of a conductive sphere to the tip of the aerial will naturally reduce the occurrence of the interference as compared with the unprotected tip. Since the atmospheric electric intensity varies over wide limits during thundery conditions, there will be times when the unprotected aerial will just attain a state of corona

while the protected aerial will remain unaffected.

It must be realized that the interference does not come on gradually as the gradient increases. There is very little interference until the critical threshold gradient is attained and then intense interference immediately results.

Thus the greater the diameter of the sphere fitted to the aerial the less are the chances of interference arising during thundery weather, but complete immunity cannot be expected.

A far better method of removing the interference, however, is to make use of a device² which does not in itself prevent corona but splits up the corona currents through a multitude of highly resistive paths.

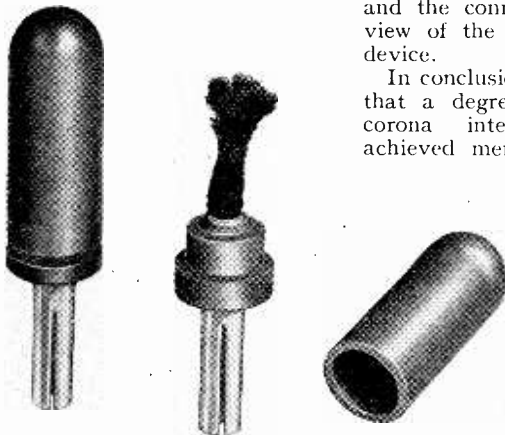

Complete "silent discharger" and, (right) the wick with protective cover removed

Under these conditions the capacitance of the aerial in series with each high-resistance path reduces, very considerably at the receiver input, the proportion of interfering energy lying within the broadcasting and communication frequency spectrum. In other words, the steepness of the wave front of the corona discharge impulses is greatly reduced.

The "silent discharger," as the writer prefers to call it, consists of a short length of soft lamp wick, one end of which is teased out into a fluffy brush. The wick is impregnated with a rapid-dry-

ing partially conductive solution, so that each fibre has a resultant high resistance. The wick is suitably mounted on a conductor and arranged for attachment to the aerial tip, and is protected by a plastic cap to prevent deterioration by the weather. Also wetting of the wick during rain will completely destroy the silent discharge properties, so that in this respect the protective cap is also necessary. The attenuation of interference on the medium waveband has in all observations exceeded 40db, while at times no level could be recorded although over 100mV of noise was generated by the unprotected control aerial.

An example of a silent discharger³ for rod aerials is shown in the accompanying photographs, which provide a view of the wick and the connecting plug, and a view of the completely enclosed device.

In conclusion, it must be stated that a degree of freedom from corona interference may be achieved merely by coating the

aerial with a good insulating compound of low permittivity and high dielectric strength. It is essential, however, that the compound be closely adherent to the aerial rod. Slipping a jacket of insulating material over the rod is unsatisfactory because the small air gap thereby provided breaks down and the corona at the interfaces is as severe as that produced in the absence of the jacket!

Even if a good quality and adherent coating is employed it is only necessary for it to be punctured on one occasion by an unduly high surface voltage gradient for it to be quite useless thereafter.

Probably some form of bitumastic compound, or some sub-

² J. R. Clement, Jr.; Seventh Partial Report on Precipitation Static Problems; U.S. Naval Laboratory Report No. 0-2309. June, 1944.

³ Patent applied for.

stance possessing sufficient cold flow to heal such punctures might prove to be satisfactory, but further evidence is required in this respect. It is only necessary for such an aerial to be severely scratched during erection to vitiate completely the inhibiting effects of the covering.

Finally, it is known that

corona discharge can cause very severe interference with the vision channel of television, although the interference to the sound channel would not appear to be so serious as to the lower frequency spectrum. The interference as viewed upon the screen appears as very large white splashes, presumably due to de-

focusing of the electron spot because of the abnormally high intensity of the individual pulses.

Unfortunately no opportunity has yet arisen to enable a test of the silent discharger to be made on television aerials, but there would appear to be no reason why the same, or possibly better, results should not be achieved.

BRITISH COMPONENTS IN SWEDEN

Local Reactions to the R.C.M.F. Show

STOCKHOLM has been the scene of a concentrated drive by the British radio industry—components, television and lectures. The exhibition, organized by the Radio Components Manufacturers' Federation, was the most important event. In spite of the minor faults which I shall discuss below, it was a really good show, and it has done a lot of good. It was a small show, with only 36 stands, but nearly all the major firms were represented, and the layout was attractive.

The Swedish visitors were both surprised and impressed. German propaganda and American publicity have combined to make Swedes think that Great Britain, the industrial heart of a community of 550 million people, survives by copying such bright ideas as magnets and jet engines. This exhibition made them think. One feature which gave a great deal of satisfaction was the fact that most stands had someone there who knew the answers. This was especially important in Stockholm, because whereas in the U.K. we simply say "Type approved?", in Stockholm they ask all the questions which type approval implies.

More Data Wanted

The chief criticism is an old friend, and dates back to before the war. There were not enough detailed technical catalogues, though the exhibition was planned long enough ago to allow of their preparation. I should also prefer to see the R.C.M.F. emulate the Physical Society, and provide a single volume, for which they would be paid. In Stockholm in-

(FROM A CORRESPONDENT)

formation about British components is hard to get. The other main criticism is a question: Why aren't valves components? Sweden needs valves of American RMA types, because Sweden's foreign customers demand this. Cannot just one British firm make these and exhibit them? Perhaps British designers would find their overseas markets prefer a single standard, too.

The immediate results of the exhibition may be depressing; trade quotas are still being negotiated as though they were ends in themselves, instead of operating on a sliding scale as devices for increasing trade. It is, however, most desirable to sell as many different kinds of components as possible to Sweden, to pave the way for expansion on a broad front. Many of these components are re-exported, serving as samples of British components in Eastern European countries. This exhibition must become an annual affair, and could, to my mind, be supplemented by a "Little Show"; a showcase of new components which could tour European factories, spending, say, one week at each. Publicity for the BS/RC specifications would help, too, especially if they could be printed decently in book form. If the publicity people and the politicians can do as well as the component industry, Europe is wide open.

Pye television put up a very good show, too, though for reasons outside their control, the arrangements discouraged quite a few visiting engineers. I was fortunate enough to see a programme from the control van when a valve

failure took place. The radiated programme showed no trace of this at all, except that there was a rather static quality in the production, as only one camera was in use. This episode provided a convincing proof of the efficiency of the production control system, for friends who saw only the broadcast programme were not aware of any failure. Picture quality was very good, and the actual equipment itself was, to my mind, extraordinarily well constructed. Until we have colour, I see no need for technical improvements, at least on the electrical side.

Lectures

Dr. Smith-Rose's lectures marked an important change in the attitude of the British Council, which is under new management in Stockholm. Physics and mathematics are part of our civilization, just as they were part of that of Leonardo da Vinci. The concentration of side issues, like theatre scenery and book printing, is wrong; the play and the contents of the book are the important things. British life is now based on a scientific background. The lectures themselves, for some reason, were not those announced, but were of the semi-popular class. Unfortunately the audience had not been warned.

Looking back on the six days, I feel that it was all much better than I expected, and that it produced much more effect than I had hoped. There really is a market in Scandinavia, but it must be cracked open. If the industry and the British Council hang together they should be able to double their present trade.

ELECTRONIC CIRCUITRY

Selection from a Designer's Notebook

LAST month two gate circuits were described, the second of which was a cathode-coupled arrangement. Another cathode-coupled arrangement suggested by the writer's colleague, Mr. T. C. Nuttall, is shown in Fig. 1. This circuit has the advantage that the output is derived in push-pull across the equal resistances R_{L1} and R_{L2} and there is no loss of gain due to R_c . The mode of operation is an extension of the simpler cathode-coupled circuit.

More Notes on Beam Switches

On the positive half-cycle of the switching wave form V_2 and V_3 are cut off by the positive excursion of the common cathode potential. On the negative half-cycle V_1 is cut off, leaving V_2 and V_3 operating as a cathode-coupled phase splitter as described by Mr. Cocking in a recent article. V_2 and V_3 may be used with either single-ended input or in push-pull

The overall gain of V_2 and V_3 , when conducting, will be nearly $g_m R_L$; g_m is, of course, the working mutual conductance of one valve.

As before, the grid-cathode capacitances of V_2 and V_3 are charged or discharged at each switching operation through whatever grid impedance there may be—in the case of one valve at least this will be the signal source impedance. Generally speaking a high switching frequency can be satisfactorily obtained only when either a low-impedance signal source (e.g., a cathode follower) is provided, or when the circuit is entirely symmetrical. Under these latter conditions any effects of switching appear at the anodes of V_2 and V_3 in push-pull and so leave the C.R.T. unaffected.

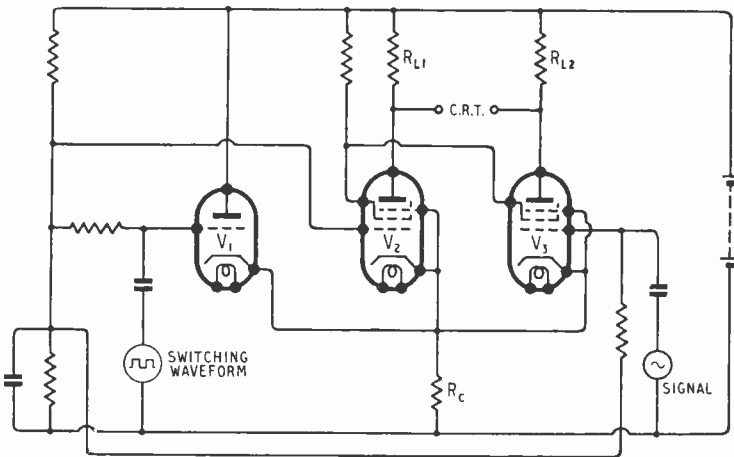

Fig. 1. Push-pull cathode-coupled gate.

as required, and in either case a push-pull output is obtained. This is very convenient as most modern cathode ray tubes are intended for symmetrical deflection. Another obvious advantage is that R_c now introduces no loss of gain, and the larger R_c is made the better balanced will be the output voltages across R_{L1} and R_{L2} .

In a two-beam switch, two such gates are used, and the V_2 anodes of each channel are used, and the V_2 anodes of each channel are connected in parallel, as are the V_3 anodes. Each signal can be given its own "shift" by arranging for a manually controlled unbalance of the standing anode currents in V_2 and V_3 and by direct coupling to the C.R.T. deflection plates.

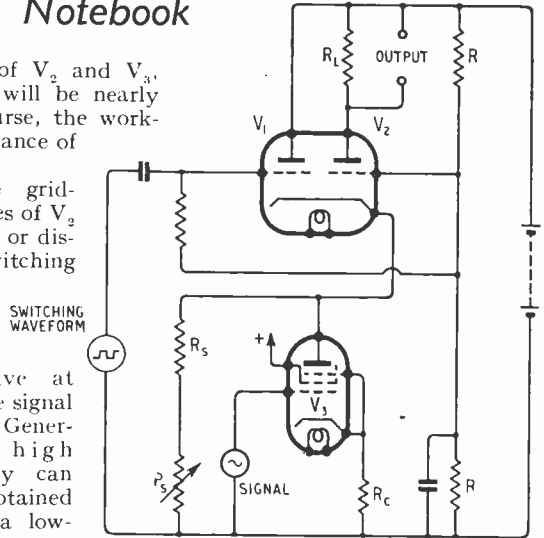

Fig. 2. High-speed gate circuit.

The last of the gate circuits to be described* is shown in Fig. 2. Here the switching waveform is applied to the double triode so that on positive half-cycles V_1 is conducting and V_2 cut off, and on negative half-cycles the reverse is true. The cathode current of the double triode is continuously modulated by the signal applied to V_3 , and when V_2 is conducting the signal voltage appears across R_L . The gain from input to output is approximately $g_m R_L / (g_m R_c + 1)$ where g_m is the mutual conductance of V_3 .

The main limitation to rapidity of switching is the stray capacitance between the anode of V_3 and earth, which has to be charged or discharged at each switching operation. This capacitance is the sum of the anode-earth (V_3), the cathode-earth (V_1, V_2) and grid-cathode (V_2) capacitances. By the use of miniature valves these can be kept to a minimum. This total capacitance has to be charged through the cathode of V_2, V_3 , and this is fortunately a low impedance point (V_1 is a cathode follower, and V_2 a grounded-grid stage). If in addition the mutual conductance of V_1, V_2 is made high, conditions are very favourable for rapid

* Patent applied for.

switching. To obtain a "shift" associated with each signal V_3 may be shunted by R_s and P_s as shown, so that by variation of P_s the standing current in R_L may be varied.

This last circuit has most of the advantages of the previous circuits and is capable of being switched extremely rapidly. Using a 6J6 for V_1 , V_2 , and an EF91 for V_3 it was not found difficult to make a beam switch with a switching frequency of 100 kc/s. By arranging to "blank" the C.R.T. for a period of about 0.15 μ sec at each switching operation, a beam switch with a switching frequency of 1 Mc/s was found to be practicable.

THE photocell is now widely used in a variety of applications, and in many of these a very short response time is unnecessary. It is not always realized that many of the difficulties of direct-

Direct-coupled Amplification for Photocells

coupled amplifiers can be avoided by using a high-resistance load for the photocell — provided it is not gas-filled. In a normal vacuum photocell it is necessary to provide a sufficient anode potential to achieve saturation (i.e. collect at the anode all electrons emitted by the cathode), and this potential is generally 20-70 volts according to the cell construction. As long as this potential is always available the cell current is independent of external resistance, so that it is possible to detect

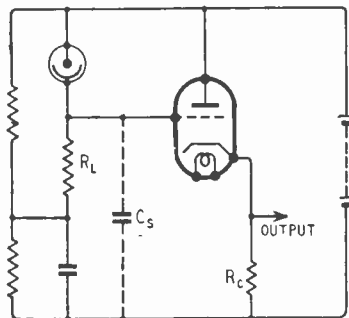

Fig. 3. Photocell amplifier C_s is the stray capacitance

minute photo-currents by developing a relatively large potential across a resistance of large value.

A simple circuit frequently

used by the writer with success is shown in Fig. 3. With a photocell load (R_L) of 100M Ω , then obviously one volt output will be obtained with 1/100 μ A cell current—corresponding to the light resulting from a 100 watt lamp about 150 ft away from a cell of average size and sensitivity. Because the "amplifier" is only a cathode follower, considerable freedom from instability can be expected. The speed of response is, however, limited by the time constant formed by the capaci-

tance at the valve grid and the load resistance. If $R_L=100M\Omega$ and the stray capacitance is 20 pF the time constant is 0.2-millisecond.

One word of warning. When using such high resistances (10-1,000 M Ω) care must be taken to eliminate stray leakages. The use of guard rings is sometimes desirable, and these may conveniently be connected to the cathode of the cathode follower. The cathode load, R_c , should be large. —J. McG. S.

HIGHLIGHTS OF CAR RADIO

New Models for Cars, Coaches and Motor Launches

BECAUSE the bulk of motor car production in this country is earmarked for export it is perhaps not surprising that the car radio sets that were shown at this year's Motor Show should cater more for overseas than for home users.

The latest Ekco production is the Model CR61 and it provides five manual tuning ranges covering 0.515 to 1.64 Mc/s, 3.3 to 7.4 Mc/s, 9.3 to 10 Mc/s, 11.5 to 12.1 Mc/s and 15 to 15.5 Mc/s. The last three it will be seen are the 31-, 25- and 19-metre bands expanded to cover the full scale. In addition there is switch selection of four pre-set stations, three in the medium and one in the long-wave band.

The receiver is a 7-valve plus rectifier superhet with permeability tuning throughout. It has an R.F. stage, push-pull output and a noise limiter. Miniature valves are used and overall size of the receiver is 7 x 7 x 4 1/2 in only. The power unit is separate and so is the control head but this only takes up 6 1/2 x 1 1/2 x 3 3/4 in. One or more external loudspeakers can be fitted.

The CR61 is available in the home market and costs £31 10s plus tax and excluding aerial. There is a home version with medium- and long-wave facilities only at £28 7s, plus tax. It is the Model 84.

A number of circuit improvements have been made to the H.M.V. car radio sets shown by Radiomobile in addition to which a

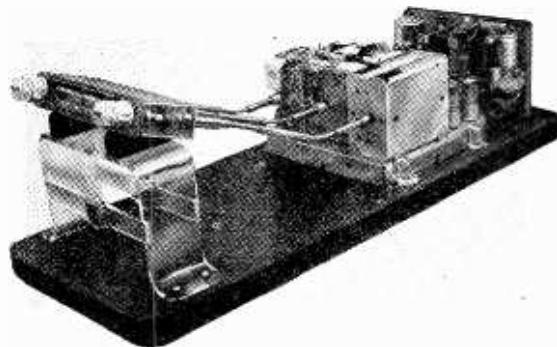

This view shows the three units of the EKCO model CR61 car radio.

new model, the 4020, has been developed for large limousine cars. Designed primarily for the Humber Pullman the set is divided into two parts, control head and main unit, respectively. The former is designed to fit into an ash-tray receptacle just below the off-side rear window and contains the R.F. and frequency changer valves, push-button and manual tuning, on-off and wave change controls. The volume control is separate.

The pre-selection mechanism is similar to that used in the Model 100 and the remainder of the set is basically the same. Separate loudspeakers are, however, employed. The price is £48, plus £12 tax, including installation and aerial.

Other firms showing home and export models include Delco-Remy-Hyatt, Masteradio, Philco, Romac and World Radio (Motorola).

A new application for car radio is appearing in the form of special equipment for motor coaches. Included are facilities for making announcements through a microphone, using the audio stages of the re-

Highlights of Car Radio—

ceiver as a small public-address amplifier.

Basically the set is a normal car

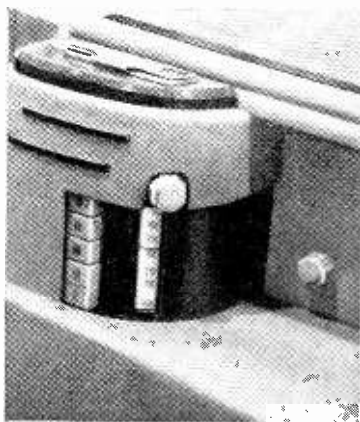

The new H.M.V. set for limousine cars has a separate control head and loud speakers with the remainder of the set stowed in the boot.

radio with a larger output stage, and provision is made to operate

several loudspeakers in the body of the coach. It is fitted in the driver's cab.

Sets of this kind are also being fitted to some of the large motor cruisers, while normal car radio sets were seen in the smaller motor launches and in caravans.

CAR RADIO**MANUFACTURERS AT EARLS COURT MOTOR SHOW**

Delco-Remy-Hyatt (Delco) (Division of General Motors Ltd.), 111, Grosvenor Road, London, S.W.1.
E. K. Cole Ltd. (Ekco), Ekco Works, Southend-on-Sea, Essex.
Masteradio Ltd., Fitzroy Place, London, N.W.1.

Philco Radio and Television Corporation of Great Britain, Ltd., Wadsworth Road, Perivale, Greenford, Middlesex.

Romac Industries Ltd. (Mellow Truth), The Hyde, Hendon, London, N.W.9.

Radiomobile Ltd. (His Master's Voice), Cricklewood Works, London, N.W.2.

World Radio Ltd. (Motorola), Edgware Road, Cricklewood, London, N.W.2.

pentode, 4.2W at 10 per cent with 165V H.T.

UY41 (31-V heater). Half-wave rectifier, 90mA.

A change in the nomenclature of two R.F. power double tetrodes is announced. In future the QV04-20 and QV07-40 types will be known as QQV04-20 and QQV07-40 respectively.

Portable Record Player

A BATTERY-OPERATED record player with carrying capacity for nine records has been introduced by Vidor, Ltd., Erith, Kent. The



Vidor Record Player

3-valve amplifier works from a combined L.T. and H.T. dry battery and the whole outfit weighs only 17lb. The price is £14 14s inclusive of tax.

MANUFACTURERS' PRODUCTS**"Mercury" Transformers and Chokes**

THIS is a new range of iron-cored components, including mains and A.F. types, introduced by



The new "Mercury" series of iron-cored components, showing a mains transformer and a small A.F. choke.

Parmeko Ltd., Percy Road, Leicester. All are vacuum impregnated and hermetically sealed in drawn copper containers with connections brought out through glass seals.

Fixing bushes are provided in both the top and the base of the container so that upright or inverted mounting can be employed

to suit surface or under-chassis wiring.

A comprehensive range of transformers and chokes, from miniatures with internal mu-metal shields, to power transformers of 170 VA, audio transformers up to 60 watts rating and smoothing chokes up to 20H at 250 mA are now available in seven different sizes of container.

The form of construction adopted protects the components against all climatic effects, from extreme cold to extreme heat and high humidity. Corrosion fungus and fumes are excluded and they are particularly well suited for use in aircraft at high altitudes and in land mobile equipment.

New Valves

FIVE new A.C./D.C. valves with 0.1A heaters have been introduced by Mullard Electronic Products, Century House, Shaftesbury Avenue, London, W.C.2. They are mounted on B8A bases and their type numbers and functions are as follows:—

UCH42 (14-V heater). Triode-hexode frequency changer.

UAF41/UAF42 (12.6-V heater). Var.-mu pentodes with single diodes.

UL42 (45-V heater). Output

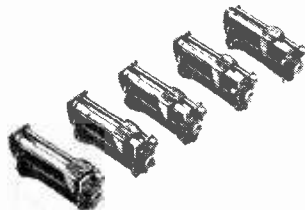

A selection of Electro Methods pre-set resistors.

THE SEE-SAW CIRCUIT Again

Applications as a Stable Wide-band Voltage Amplifier

PARTLY as a result of its use in war-time radar, but also because it is being realized that it can be used as a versatile feedback amplifier stage the see-saw or anode follower circuit is becoming more and more popular. It has been well described in several journals¹⁻⁶, but these descriptions have usually been confined to the discussion of the conditions required for a gain of unity, for use as a phase reversal stage in push-pull amplifiers. By analogy with the cathode follower the circuit is sometimes called the anode follower—a name to be deprecated as the anode potential does *not* follow that of the grid;

By **J. McG. SOWERBY, B.A.,**
Grad.I.E.E.
 (Cinema Television, Ltd.)

ment may be effected by the introduction of additional capacitances C_i , C_f (shown dotted) across R_i and R_f respectively, a feedback independent of frequency cannot be obtained. This is obvious when it is remembered that R_g , R_i , R_f , and R_a in parallel with the impedance of the valve form a π circuit, and the capacitances C_i , C_g , C_f , and C_a (the stray anode capacitance) form a loaded T circuit.

Design of the T See-Saw.—If the see-saw is to be designed for a fairly wide bandwidth, as in an oscilloscope amplifier for example, it is usually necessary to make R_a relatively small, and it is then easy to arrange that the resistance looking back into the T from the anode of the valve is large compared with R_a . Hence it will be sufficiently accurate for most practical purposes to assume that the anode load resistance is unmodified by the introduction of the T, but that the capacitance C_i must be added to C_a in calculating the high-frequency performance.

The overall gain $E_{12}/E_{AB} = A$

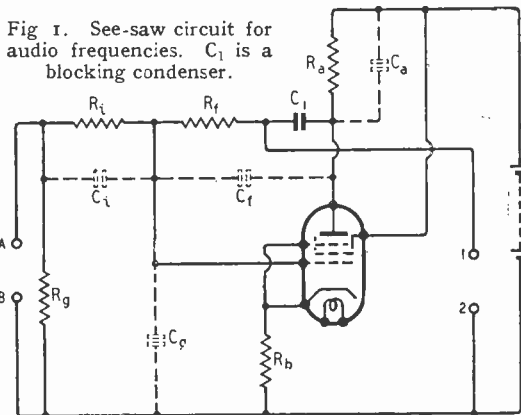

Fig. 1. See-saw circuit for audio frequencies. C_1 is a blocking condenser.

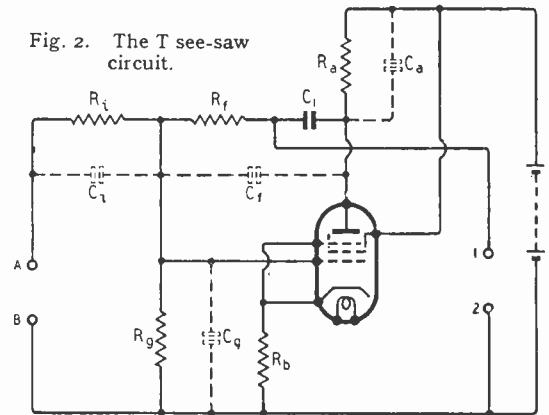

Fig. 2. The T see-saw circuit.

they are, in fact, reversed in phase.

A gain of unity is by no means essential to the see-saw circuit, and a gain of anything less than the gain of the stage alone (without the see-saw attachments) can be obtained, as will be seen from the following notes.

There are two ways in which the see-saw circuit may be connected. In Fig. 1, is shown a common arrangement which is quite suitable for low-frequency work—up to 10 kc/s, say. This connection is, however, unsuitable for the higher frequencies because as soon as the reactance of the grid—earth capacitance C_g (shown dotted) becomes comparable with R_i or R_f , the gain begins to change with frequency. Although an improve-

If the use of frequencies above the audio range is contemplated, it is preferable to arrange the see-saw as in Fig. 2. It is obvious that the network now forms a loaded T circuit composed of three impedances Z_i , Z_f and Z_g , each of which is of the same character being composed of a resistance shunted by a capacitance. By making the time constants of the three arms equal (i.e. $R_i C_i = R_g C_g = R_f C_f$) the T network becomes independent of frequency, and the only capacitance which plays any great part in the attenuation of high frequencies is C_a —to which must be added the apparent capacitance C_i , presented to the anode of the valve by the T network.

can be expressed in terms of three parameters: the gain without feedback $A_0 = E_{12}/E_{g0}$, the attenuation α through the T alone from terminals AB to the grid of the valve, and the feedback factor β which is the attenuation of the T alone from terminals 1, 2, to the grid. A short-circuited termination is assumed in each case. The overall gain is thus

$$A = \frac{\alpha A_0}{1 + \beta A_0}$$

We may proportion α and β more or less as we please to yield the required overall gain. We could, for example make β approach zero (by making R_f exceedingly large) and then simply choose α to give the required

The See-Saw Circuit Again—

overall gain. But by doing this we should have thrown away the possibility of reducing the distortion and output impedance by feedback. If we go to the opposite extreme and make α approach unity (by making R_f very small and control the gain almost entirely by feedback, then the input impedance becomes very small and the stage is consequently difficult to drive. Another assumption has to be made before useful design data can be derived. The assumption has been made here that $(R_i + R_f) = R_o$ as this represents a reasonable compromise in most practical cases between too little feedback, and too low an input impedance.

As will be seen from the Appendix (equation 5), the analytical results are not very convenient to handle, and the design of a see-saw stage is more easily tackled graphically with the aid of the curves of Fig. 3. These show A (over the range 1 to 100)

been drawn for A_o infinitely high so the results with values of A_o exceeding 500 may be estimated.

Having found a suitable value of R_f/R_i from the curves—by interpolation if necessary—and assumed a convenient and reasonable value for R_o , it is a simple matter to find R_f and R_i from $R_i = R_o / (1 + R_f/R_i)$ and $R_f = R_o - R_i$. Trimmer condensers may then be added to make the time constants equal in all the arms of the T network. The input resistance is then virtually R_i , and the input capacitance C_i is given by equations (9) and (10) of the Appendix. The output res-

$R_o = \left(\frac{1}{g_m} + R_o\right)F$ and the factor F may be taken from the curve so labelled in Fig. 3.

The high-frequency response

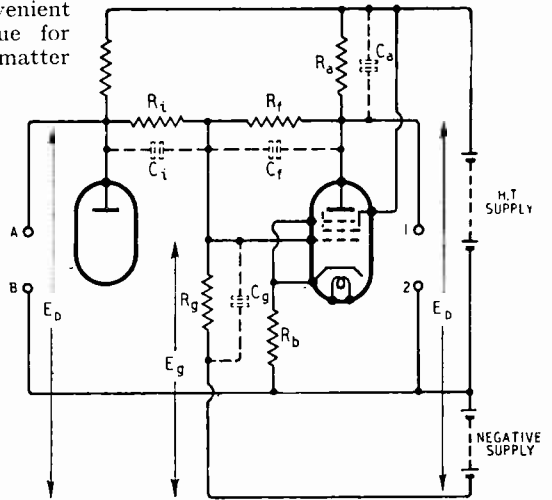

Fig. 4. Direct coupled see-saw circuit.

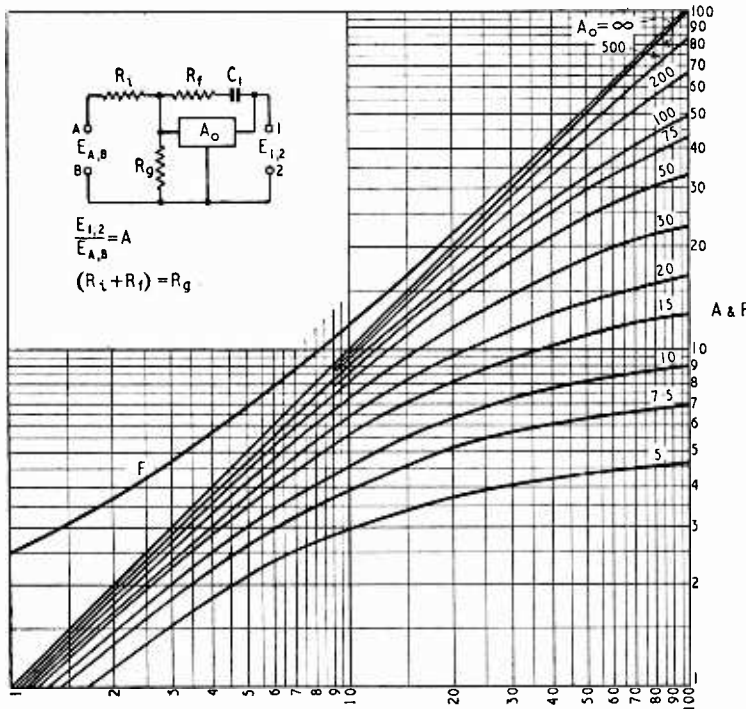

Fig. 3. Curves connecting A and F with R_f/R_i for see-saw circuit, T connection.

for various values of R_f/R_i for gains without feedback (A_o) between 5 and 500. A curve has

sistance is modified by the feedback, and this is conveniently described as a low resistance R_o in parallel with R_a , so that the total output resistance $R' = R_o R_a / (R_o + R_a)$. From the Appendix we may take the result

of the stage is determined by the stray capacitance across R' , and this is composed of C_a and C_f . Calling this total capacitance $C' = (C_a + C_f)$, the frequency at which the response is three decibels down is

$$f_c = \frac{160}{C'R'} \quad C' \text{ in } \mu\mu\text{F} \quad f_c \text{ in Mc/s}$$

For most purposes it is sufficiently accurate to assume that $C_i = C_f$; see equation (10a) in the Appendix.

Direct Coupled See-Saw.—The L.F. response of the circuit of Fig. 2, is limited by the blocking condenser C_1 , and if a response down to zero frequency is required, the direct-coupled see-saw of Fig. 4 may be adopted. The arrangement is not generally suitable for an input stage, because it has a relatively low input resistance and the gain is partially independent on the internal impedance of the signal source. The circuit is however suitable for subsequent stages,

It will be remembered that for the circuit of Fig. 2, we make the reasonable assumption that $(R_i + R_f) = R_o$ thus fixing the relative values of feedback and attenuation for a given overall gain. In the circuit of Fig. 4 we need to

make no such assumption, as the conditions are already fixed by the required distribution of standing potentials. These may be almost anything within reason, each leading to different results. It seems reasonable, therefore, to present the conditions for the particular case when the standing potentials at input and output

are equal. This case is particularly useful as stages may be cascaded without further trouble; always provided, of course, that R_a is low compared with the resistance of the T network. Except for the extension of the frequency response to zero frequency, the circuit behaviour of Fig. 4 is the same as that of Fig. 2.

APPENDIX

A = Stage gain
 A_0 = Gain of valve alone
 $= g_m Z_a / (g_m R_b + 1)$
 g_m = Mutual conductance of valve.
 To find the overall gain of Fig. 2. We may write:

$$A = \frac{\alpha A_0}{1 + \beta A_0} \dots (1)$$

Where

$$\alpha = \frac{R_f R_g}{R_i (R_f + R_g) + R_f R_g} \quad (2)$$

and

$$\beta = \frac{R_f R_g}{R_f (R_i R_g) + R_i R_g} \quad (3)$$

Substituting for α and β in (1)

$$A = \frac{R_f R_g A_0}{R_f (R_i + R_g) + R_i R_g (A_0 + 1)} \quad (4)$$

or

$$A = \frac{A_0 R_f / R_i}{\frac{R_f}{R_i} \left[1 + \frac{1}{\frac{R_f}{R_i} + 1} \right] + A_0 + 1} \quad (5)$$

when $(R_i + R_f) = R_g$

To find the input impedance

The signal potential across R_g is

$$E_{gc} = \frac{A E_{AB}}{A_0} \dots (6)$$

But the signal potential across R_i is

$$E_{AB} - E_{gc} = E_{AB} (1 - A/A_0) \quad (7)$$

and the signal input current is

$$I_{in} = \frac{E_{AB} (1 - A/A_0)}{R_i} \dots (8)$$

Hence the input resistance is

$$R_{in} = \frac{E_{AB}}{I_{in}} = \frac{R_i}{1 - A/A_0} \quad (9)$$

Similarly the input capacitance is

$$C_{in} = C_i (1 - A/A_0) \dots (10)$$

And in the same way the input capacitance, C_i , looking back into the T network from the anode is given by

$$C_i = C_f (1 - 1/A_0) \dots (10a)$$

To find the apparent anode resistance R_0 of the valve.

Let a potential V_{12} be applied to the anode of the valve and let the consequent potential at the grid be v_g .

$$v_g = \beta V_{12} \dots (11)$$

The resultant valve anode current is

$$i_a = g_m (\beta V_{12} - i_a R_b)$$

or

$$i_a = \frac{g_m \beta V_{12}}{1 + g_m R_b} \dots (12)$$

Hence the apparent anode resistance is

$$R_0 = \frac{V_{12}}{i_a} = \frac{1}{\beta} \frac{1 + g_m R_b}{g_m}$$

or

$$R_0 = \left(\frac{1}{g_m} + R_b \right) F, \dots (13)$$

where $F = \frac{1}{\beta}$

From (3), when $(R_i + R_f) = R_g$,

$$\frac{1}{\beta} = F = \frac{R_f}{R_i} \left[1 + \frac{1}{\frac{R_f}{R_i} + 1} \right] + 1 \quad (14)$$

Referring to Fig. 4

To find R_f and R_i for a given overall gain, A ,

$$(\alpha + \beta) = \frac{E_g}{E_D} = E \text{ and } \alpha \text{ and } \beta$$

are defined by (2) and (3).

Hence

$$\alpha + \beta = \frac{R_f R_g + R_i R_g}{R_i (R_f + R_g) + R_f R_g} = E$$

Whence

$$R_i = \frac{R_f (1 - E)}{E \left(\frac{R_f}{R_g} + 1 \right) - 1} \dots (15)$$

From (4),

$$R_i = \frac{1}{A} \frac{R_f R_g A_0 - A R_f R_g}{R_f + R_g (A_0 + 1)} \quad (16)$$

Equating (15) and (16).

$$R_f = \frac{(1 - E)(A + 1)}{E - A/A_0} R_g \quad (17)$$

Substituting (17) in (15) we find

$$R_i = \frac{(1 - E)(A + 1)}{A(E + 1/A_0)} R_g \quad (18)$$

To find the apparent anode resistance, R_0 , of the valve.

From (13),

$$R_0 = \frac{1}{\beta} \left(\frac{1}{g_m} + R_b \right) \dots (19)$$

Substituting (17) and (18) in (3), and

substituting the result for $\frac{1}{\beta}$ in (19)

$$R_0 = \frac{A + 1}{E - A/A_0} \left(\frac{1}{g_m} + R_b \right) \quad (20)$$

Extracting the relevant results from the Appendix:

$$R_i = \frac{(1 - E)(A + 1)}{A(E + 1/A_0)} R_g$$

where $E = \frac{E_g}{E_D}$

$$\text{and } R_f = \frac{(1 - E)(A + 1)}{E - A/A_0} R_g$$

As before, the output resistance $R' = R_0 R_a / (R_0 + R_a)$, and

$$R_0 = \frac{A + 1}{E - A/A_0} \left(\frac{1}{g_m} + R_b \right)$$

The calculations of H.F. performance are exactly as before.

It is hoped that the foregoing notes will facilitate the design of see-saw circuits. They can be used in standard laboratory amplifiers, oscilloscope amplifiers, and in fact whenever a stable voltage amplifier of low output impedance is required. The writer has found the circuit of particular use in oscilloscope amplifiers when a wide-band frequency response (e.g. 0 c/s - 5 Mc/s) is needed, the effective load capacitance is liable to variation according to the conditions of use, and adequate inductive compensation is consequently difficult of satisfactory realisation. Occasionally the see-saw circuit might be useful as a low gain phase-inverting video amplifier.

Thanks are due to the writer's colleague, Mr. T. C. Nuttall, for helpful discussion on the applications of see-saw circuits.

REFERENCES

¹ Brit. Pat. No. 325833.
² M. G. Scroggie, *Wireless World*, July 1945, p. 194.
³ R. E. H. Carpenter, *Wireless World*, Sept. 1945, p. 263.
⁴ F. C. Williams, *J.I.E.E.* Vol. 93, Part IIIA No. 1, p. 289 (1946).
⁵ F. C. Williams, F. J. U. Ritson and T. Kilburn, *J.I.E.E.* Part IIIA, No. 7 p. 1275 (1946).
⁶ W. T. Cocking, *Wireless World*, Apr. 1948, p. 126.

NEW TELEVISION RECEIVERS

THREE new television receivers have been added to the range made by Ultra Electric, Western Avenue, London, W.3. The Model D570, costing £141 15s 6d, is of the superheterodyne type with 21 valves and has automatic frequency control as well as A.V.C. on the sound channel. The 12in tube gives a black-and-white picture 8in x 8in.

Model W570 is technically similar to the D570 but has a less expensive cabinet and costs £90 4s 6d, while the W470 with 20 valves and a picture 7in x 6in costs £77 6s 8d, including tax.

WORLD OF WIRELESS

Set Manufacture ♦ Television News ♦ Naval Recruiting ♦ U.N. Radio

Relaxation of Controls

THE Government Order (S.R. & O. 226/47) controlling the manufacture and supply of broadcast and television receivers and radio-gramophones has been revoked. Under this Order, which was designed to limit production for the home market and encourage export, licences were issued yearly for definite quotas for sets for this country, while for export, licences were issued against firm orders, or, in the case of manufacturers with a well-established export trade, for an export production programme.

Among the many other products and materials on which control has been withdrawn are gramophone records and accumulators.

U.S. Television Standstill

THE mushroom-like growth of American television has been stopped. The F.C.C. has decided not to issue further licences for the building of television stations to operate in twelve of the thirteen channels until a decision has been reached on the question of possible changes in television engineering standards. This may take six or nine months.

There are at the moment about forty stations on the air and some eighty in the process of building. It is, however, the number of pending applications for licences which is significant—some 300.

The position has apparently been reached where the number of proposed television stations has outgrown the accommodation of the thirteen channels available. These channels range from 44-216 Mc/s and the decision affects all but the lowest—44-50 Mc/s.

Our Washington contemporary, *Broadcasting*, states that the F.C.C. made it clear that it intends to provide more space for television in the 475-890 Mc/s band.

Télévision Française

THE note in our November issue on the provision of high-definition television equipment for France was a little ambiguous.

The position is that the Paris 455-line television system is to continue until 1956, but during this period experiments with higher definition systems are to be carried out by the broadcasting authority, Radiodiffusion Française. To this

end it has accepted from the Compagnie Radio-Industrie the 819-line equipment referred to. R.D.F. has also asked the Compagnie Française Thomson-Houston to provide equipment for 729 lines, and still higher definition gear (1029 lines) is being supplied by the Compagnie des Compteurs.

A new transmitter is to be erected at Lille, which it is anticipated will provide a higher definition service. The decision on this is expected to be delayed until the three experimental systems have been tested. The station is planned to be in service toward the end of 1949.

Naval Radio Officers

THE Admiralty has announced a scheme for Short Service Commissions in the Electrical Branch of the Royal Navy to former officers of the Royal Naval Volunteer Reserve who were employed on technical duties connected with radar, wireless and air radio.

Candidates, who must have completed one year's mobilized service as an officer, and be under the age of 35 on January 1st, 1949, will be entered in the substantive rank, and with the relative seniority in that rank, which they held at the time of their release. They will be eligible for promotion under the normal rules. Service will be for five years on the Active List and four years on the Emergency List.

Applications should be made to the Director of Naval Electrical Department, Admiralty, Queen Anne's Mansions, London, S.W.1, from whom further details are obtainable.

R.N.V.(W.)R.

WITH the object of training telegraphists to serve in the fleet in a national emergency until the ordinary mobilized men have been trained for the task, the Admiralty re-constituted some months ago the Royal Naval Volunteer (Wireless) Reserve. The prescribed strength is 39 officers and 1,200 telegraphists.

So far only 200 ratings have been enrolled at the training centres established in London, Grimsby, Hove and Northampton. Twenty-five other training centres will be equipped. Training is essentially operational. When a trainee has reached a sufficiently advanced stage in his training he is lent a

naval transmitter and receiver for home use, and is granted an allowance of £3 a year for maintenance and operation costs.

Trainees must be between 17 and 26, unless they have served in the Navy, when they are eligible up to 45. Period of service is five years.

Details of benefits, bonuses, periods of training, etc., are obtainable from Naval Reserves, Admiralty, Queen Anne's Mansions, London, S.W.1.

Long-Distance Television

ALL records for long-distance television reception were broken recently when a transmission from Alexandra Palace was resolved in Cape Town—nearly 6,000 miles.

Having picked up on occasions the television sound channel, an amateur, H. Reider, secured from this country a standard Pye B16T receiver in the hope of receiving a picture. This set was used successfully without pre-amplification.

It had been predicted (*see* "Short-wave Conditions," October issue) that long-distance working on very high frequencies would frequently be possible during the month.

Australian Broadcasting

FOR some time there has been agitation in Australia for the whole of radio administration to be taken out of the hands of the Postmaster-General and placed under the control of a communications board as is done in the U.S.A.

A step in this direction has now been taken by the Federal Government which proposes the transfer of the control of broadcasting from the P.M.G. to a board of three members having no financial interest in broadcasting or associated industries. This board will not replace the Australian Broadcasting Commission which will continue to operate the thirty national stations. The hundred or so commercial stations are operated by individual companies or organizations. The activities of these stations are co-ordinated by the Federation of Commercial Broadcasting Stations.

United Nations Radio

AT very short notice, the French broadcasting organization, aided by the French radio industry, has installed an exceptionally complete equipment for the broadcasting and recording of speeches at the Paris session of the United Nations Organization. About 28 hours daily of short-wave broadcast transmissions can be effected, and facilities are provided for up to 35 simultaneous commentaries in duplex. Links with the broadcasting systems

of many countries allow of direct or delayed recorded re-broadcasts. Some 16,000 disc recordings are expected to be made during the session.

In addition to the facilities provided by R.D.F. the technical services of the U.N. organization have been installed in the Palais de Chaillot equipment enabling delegates to hear speeches simultaneously translated into any one of the five official languages.

Amateur Licences

THE present arrangement whereby Service experience is accepted by the P.M.G. as giving exemption from parts of the examination for an amateur transmitting licence will be slightly modified from January 1st. From that date the exemption will be granted only if applicants have been engaged in the specified Service trades or duties within two years of the date of the application for a licence.

OBITUARY

It is with regret we record the death on November 3rd of **H. Bevan Swift**, who was past president of the R.S.G.B. He was 74 years old. Following his presidency of the society from 1931 to 1933 he was honorary editor of the *R.S.G.B. Bulletin* until 1940. In recognition of his work for the society, which went back to the pre-broadcasting days, he was elected an honorary member in 1930. He will be remembered by many as a chairman of the old T. & R. Section.

PERSONALITIES

C. G. Allen, the well-known radio amateur (G8IG) and sales manager of McMichael Radio, has been appointed to the company's Board of Directors. It was in 1923 that he joined McMichael's, prior to which he was a radio operator with the Marconi International Marine Communication Co. Radio is his business and hobby! Another appointment to the Board is that of **J. A. Klein**, who is export manager.

H. Bishop, C.B.E., B.Sc.(Eng.), chief engineer of the B.B.C., has been elected a vice-president of the I.E.E. He was chairman of the Radio Section for the 1941-42 session.

Dr. E. H. Colpitts, who is known throughout the radio world because of the circuit which bears his name, has been awarded the Cresson Medal of the Franklin Institute, New York, for his work in the development of long-distance radio communication.

P. R. Coursey, B.Sc.(Eng.), technical director of Dubilier, gave a lecture on the standardization of components to 150 technical officers of the Swedish Armed Forces during the recent exhibition of British radio components in Stockholm.

H. J. Denham, C.B.E., M.A., D.Sc., who served as a member of the Ordinance Board with the rank of Colonel from 1944 until 1946, has been re-appointed as a civilian member of the

Board which is the inter-Service authority on armaments. Dr. Denham has also been appointed Head of the Electronics Division of the Board.

H. Faulkner, Deputy Engineer-in-Chief, G.P.O., has gone to Mexico as joint leader of the British delegation to the International Administrative High-Frequency Broadcasting Conference which opened on October 22nd. The delegation also includes **L. W. Hayes**, **F. Axon** and **R. A. Craig** of the B.B.C. and **P. W. Fryer** and **P. N. Parker** of the G.P.O.

L. W. Hayes, who is head of the B.B.C. Overseas Engineering Information Dept., is resigning from the service of the Corporation at the end of the year in order to take up his recent appointment to the International Radio Consultative Committee (C.C.I.R.) as vice-director for broadcasting. The C.C.I.R. is one of the constituent bodies of the International Telecommunication Union. Mr. Hayes, who has been with the B.B.C. for over 23 years, is at present in Mexico for the H.F. Broadcasting Conference. When he takes up his new appointment in January he will reside in Switzerland.

IN BRIEF

Licences.—Despite the increase of 4,000 in the number of television licences issued during September, bringing the total to 66,600, the total number of receiving licences had decreased during the month by approximately 13,000. The only apparent reason for this is the tardiness of listeners in renewing expired licences. The comparative figures are: August, 11,324,000; September, 11,311,200.

Danish Television.—A correspondent points out that, in spite of the enthusiasm with which the public received the television demonstrations during the British Exhibition, the

attitude in official circles is "wait and see what is adopted as a European standard." No decision is likely to be taken, however, until the attitude of Norway and Sweden is known. Opinion is sharply divided on the question of definition. It is understood the offer, at a nominal price, of the Pye equipment used for the demonstrations has not been accepted.

Navigation.—H.R.H. the Duke of Edinburgh will open the exhibition "Navigation through the Ages," which is being organized jointly by the Institute of Navigation and the Royal Geographical Society, on December 17th. It will be open free to the public from December 18th to January 20th at the R.G.S., 1, Kensington Gore, London, S.W.7. Radio aids will be a feature of the exhibition.

Radiolympia.—The Radio Industry Council has appointed an organizing committee for the Sixteenth National Radio Exhibition which it is planned to hold at Olympia next autumn. The chairman of the Committee is **F. W. Perks** (E.M.I.) and the vice-chairman **V. M. Roberts** (B.T.H.). The remaining seven members are **R. Arbib** (Multi-core), **B. J. Axten** (S.T.C.), **A. F. Bulgin**, **H. J. Dyer** (Philips), **F. V. Green** (S.T.C.), **F. Jones** (Marconi-Phone) and **W. M. York** (Eko).

Components Exhibition.—The sixth annual private exhibition of radio components, materials and test gear, organized by the Radio Component Manufacturers' Federation, will be held at Grosvenor House, Park Lane, London, W.C.1, from March 1st to 3rd.

E.M.I. Evening Courses.—Three evening courses, each of three months' duration, dealing respectively with Practical Television, Television Principles and Practical Radio, are to be introduced by E.M.I. Institutes. Details of the courses, which are planned for students with some knowledge of the fundamentals, are obtainable from

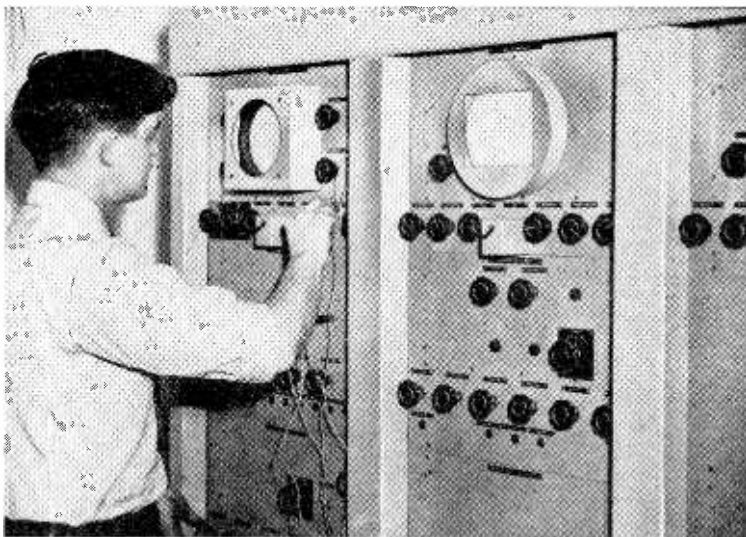

SOBELL INDUSTRIES installed a specially built television transmitter at the recent Ideal Homes Exhibition in Birmingham in order to demonstrate their receivers on a closed circuit.

World of Wireless—

the Principal, E.M.I. Institutes, Ltd., Grove Road, Chiswick, London, W.4.

Brit.I.R.E. Officers.—As previously announced, the new president of the Brit.I.R.E. for 1948-49 is L. H. Bedford, who succeeds the Earl Mountbatten, who is now vice-president. W. E. Miller, Editor of our associated journal *The Wireless & Electrical Trader*, who has been chairman of the council since 1946, was elected a vice-president. The new ordinary members of the council are Prof. H. M. Barlow, H. A. Brooks, Cdr. A. J. B. Naish, L. H. Paddle and Dr. W. J. Thomas. J. W. Ridgeway was re-elected on the council.

Outward Form.—Various stages in the development of the Ekco "Radio-time" receiver and the Murphy V16 television set are illustrated and described at the exhibition of "Design at Work" at Burlington House, Piccadilly, London, W.1.

Europe's New Wavelengths.—The list of Copenhagen Frequency Allocations, published in the November *Wireless World*, is now available from our Publishing Office as a reprint, price 6d post free.

Great Circle Map.—Many reprints of the *Wireless World* Great Circle Projection Map have been issued since it was first drawn by the late J. St. Vincent Pletts at the time when worldwide radio communication was beginning. A new edition, containing extra tabulated information on standard times and geographical positions, has just been issued. This map, giving the true bearing and "radio" distance to any part of the world from London, is obtainable from our Publisher, price 2s 6d, plus 3d postage and packing.

"W.W. Diary."—All copies of the *Wireless World* Diary, 1949, have now been distributed to stationers and booksellers. The eighty reference pages contain information, mostly technical, of the kind so often needed by radio men but seldom memorized. The price, including P.T., is 3s 4½d.

INDUSTRIAL NEWS

Pye Australasia, Ltd., is the name under which a new company, formed in Australia jointly by Pye, Ltd., of Cambridge, and Electronic Industries, of Australia, will operate.

Chilian Agency for valves and condensers is sought by John Cameron Reid e Hijos, Agustinas 1070, Of.131, Santiago. Information regarding the company may be obtained from the Export Promotion Department, Board of Trade, Thames House North, Milbank, London, S.W.1, quoting ref. 41024/48.

P.E.R.A.—The official opening of the Production Engineering Research Association of Great Britain at Staveley Lodge, Melton Mowbray, which has actually been established for some months, took place on October 26th. P.E.R.A. has been established to "assist the engineering industry in improving its efficiency of production."



PRESS - BUTTON RECORD PLAYER—In this new single-record player introduced by the Plessey Co., Ilford, Essex, the pickup is automatically lifted and placed at the start of 10-in. or 12-in. records by pressing the appropriately marked operating lever. A moving-iron pickup is standard and the turntable is rim-driven by a constant speed A.C. motor.

It is assisted financially by the Government, which donates £1,000 p.a. for every £1,000 subscribed by industry, and recently granted £25,000 for the purchase of equipment.

Iron-cored Components.—Samples and prototypes, as well as long-production runs, of power and A.F. transformers and inductors, can be handled by a new firm, the Transformer Equipment Co., Ltd., St. Mark's Road, Bromley, Kent. The range of sizes extends from miniature communications components to units of 10 kVA capacity.

Wright & Weaire point out that although restrictions prevent the import of coils and coil products complete to certain countries it is possible to supply the mechanical parts of a coil pack, leaving the manufacturer to assemble his own coils. The company's three-coil unit, with pre-formed wiring and built-in wave-change switches, which is totally enclosed and measures 4½ x 4 x 1½ in., can be supplied without coils.

Plastics "Hall Mark."—A scheme has been launched jointly by the British Plastics Federation and the British Standards Institution for the certification of plastic materials and products. At present the certification mark, which is in the form of a circle with the initials B.S. in the centre and B.P.F. on the left-hand side, is only applicable to moulding powders made from phenol formaldehyde and urea formaldehyde resins and certain mouldings made from these.

MEETINGS

Institution of Electrical Engineers
Radio Section.—"Fixed Resistors for use in Communications Equipment, with special reference to High Stability Resistors" by P. R. Coursey,

B.Sc. (Eng.), at 5.30 on December 1st. Discussion on "V.H.F. Mobile Radio-Telephone Services" opened by D. H. Hughes, at 5.30 on December 14th.

The above meetings will be held at the I.E.E., Savoy Place, London, W.C.2.

Cambridge Radio Group.—"Three-Dimensional Cathode-Ray Tube Displays," by E. Parker, M.A., and P. R. Wallis, B.Sc. (Eng.), at 8.15 on December 7th at the Cavendish Laboratory, Cambridge.

North-Eastern Radio and Measurements Group.—"Three-Dimensional Cathode-Ray Tube Displays," by E. Parker, M.A., and P. R. Wallis, B.Sc. (Eng.), at 6.15 on December 20th at King's College, Newcastle-on-Tyne.

Northern Ireland Centre.—"Analysis-Synthesis Telephony, with special reference to the Vocoder," by R. J. Halsey, B.Sc. (Eng.), and J. Swaffield, Ph.D., at 6.45, on December 14th, at Queen's University, Belfast.

British Institution of Radio Engineers
London Section.—"Physical Applications of Microwaves," by J. B. Birks, B.A., at 6.0, on December 16th, at the London School of Hygiene and Tropical Medicine, Keppel Street, London, W.C.1.

South Midlands Section.—"Heating by Centimetric Power," by R. Keitley, B.Sc., at 7.0, on December 16th, at the Technical College (Room A5), The Butts, Coventry.

Merseyside Section.—"Negative Feedback," by J. Durnford, at 6.45, on December 15th, at the Incorporated Accountants' Hall, Derby Square, Liverpool, 2.

Radio Society of Great Britain

London Meeting.—"Equipment for the 144 Mc/s Band," by E. A. Dedman, at 6.30, on November 26th, at the I.E.E., Savoy Place, London, W.C.2.

Television Society

Midlands Centre.—"Studio Technique in Television," by D. C. Birkinshaw, M.B.E., M.D., at 7.0, on December 1st, at the Chamber of Commerce, New Street, Birmingham.

Institute of Physics

Electronics Group.—"Gas Discharge Tubes," by G. F. Heymann, M.Sc., at 7.0, on December 7th, at the University, Glasgow.

British Sound Recording Association

London Meeting.—"Some Physiological Factors in Quality Appreciation," by E. A. Vetter, at 7.0 on December 17th at the Royal Society of Arts, John Adam Street, London, W.C.2.

Institute of Navigation

"Radio and Position," by Sir Robert Watson-Watt, C.B., F.R.S., at 5.0 on December 17th at the Royal Geographical Society, 1, Kensington Gore, London, S.W.7.

Royal Society of Arts

"Television and Education," by Mrs. Mary Adams, at 8.0 on November 29th at the R.S.A., John Adam Street, London, W.C.2.

Junior Institution of Engineers

"New Developments in Broadcasting," by Sir Noel Ashbridge, President, at 6.30 on December 10th at the R.S.A., John Adam Street, London, W.C.2.

With the January issue, the price of WIRELESS WORLD will be 2/-

STABILIZED POWER SUPPLIES

3.—Extension of Output Voltage Range

WE come lastly to the problem of extra-wide ranges of output voltage. Maximum V_o can be extended in the upward direction by increasing the supply voltage and the maximum value of R_1 ; but, as the working-out of a design with the aid of Fig. 4 showed, unless the minimum V_o is raised equally it is necessary to provide series valves capable of greater anode dissipation. Alternatively, and more economically, the full range of control can be split up into two or more bands by means of a switch controlling E_s (the source voltage) and R_{1a} simultaneously in steps (footnote reference 4, Part 2). The value of R_{6a} , if used, ought also to be changed; but in practice it will be found that when R_{1a} considerably exceeds R_2 the error due to

By M. G. SCROGGIE

B.Sc., M.I.E.E.

omitting R_{6a} altogether is unimportant.

Lowering the minimum V_o is less straightforward. As we saw in Part I, the limiting condition with the circuit considered until now is that V_o must be sufficient to supply V_{N1} , V_{2a} and V_{1g1} (max) in series. The lowest available V_{N1} is about 50 V; V_{2a} can hardly be reduced below 20 V, and in our example V_{1g1} (max) was 66 V, making 140 V about the lowest practicable V_o . Further reduction, down to perhaps 100 V, could be obtained at the expense of range of V_o control.

For some purposes, however, it may be desirable to extend the range down to zero volts. This

can be done by providing a source of negative potential for V_2 . Such a source can conveniently be made to add still further to the facilities of the unit by providing an external grid bias supply.

Although the modification to the circuit is fairly obvious in principle, there are a number of practical details that require care and attention. These will be discussed with reference to Fig. 13, an extension of the previous design, to cover 0-500 V in two equal bands.

Since $N1$ cannot be fed from the main stabilized output it is necessary to consider very carefully the effects of its A.C. resistance. Any voltage variations across it are amplified perhaps 2,000 times and injected into the main supply, and are not reduced by feedback. The most effective way

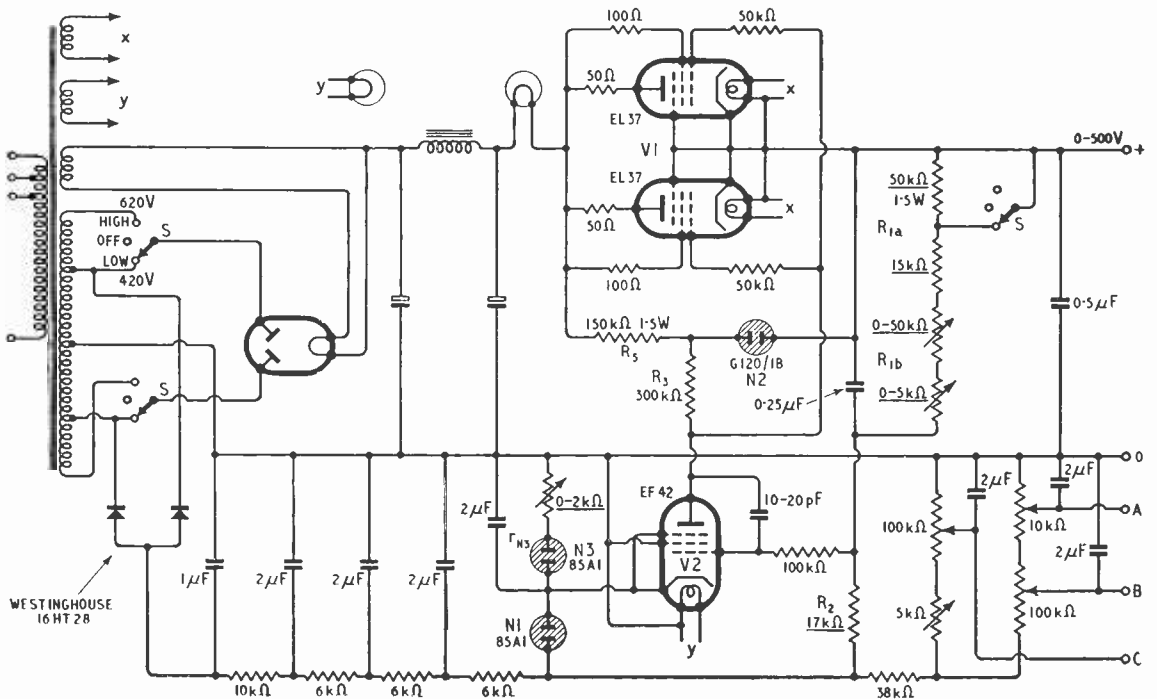

Fig. 13. Modification of Fig. 7 to provide output voltage variable over the range 0-500 V. The resistors underlined at least, should be wire-wound. The outputs obtainable from the negative terminals are:—A, 0 to -9 V, or fine control of B if shorted to 0; B, -9 to -100 V, or 0 to -100 V with fine control if A shorted to 0; C, 0 to -100 V with fine control.

Stabilized Power Supplies—

of avoiding them is to stabilize the auxiliary negative supply; but this is somewhat elaborate, necessitating a separate transformer H.T. winding, valves, etc.

The alternative is to smooth the negative supply very thoroughly. It should be noted that while hum can be reduced by reactances, slow fluctuations in mains voltage are reduced only by series resistance. It is therefore necessary for this resistance to be high. The supply in Fig. 13 is taken from 420 V tappings on the mains transformer, using a pair of Westinghouse 16HT28 metal rectifiers. The 620 V tappings, with appropriately rated components, would be better still. Current in this supply should be kept as small as possible, the requirement for large smoothing resistance overriding the rectifier maximum rating of 15 mA. The reservoir capacitance is limited by the rectifier rating to 1 μ F.

The effect of the resistance between screen grid and cathode of V2 is quite different in this circuit. It forms one arm of a bridge, the others being r_{N1} , R_2 and R_1 (completed by the negligible R_o). V2 (grid to cathode) is the detector, and the negative supply is the signal source. To eliminate the effect of slow fluctuations in the latter completely, therefore, it is only necessary to make $R_{g2-k} = r_{N1}R_1/R_2$. Such a resistance, being quite insufficient to supply V_{2g2} , must be supplementary to a tube N3; 0-2k Ω would usually do.

Unfortunately the value of R_{g2-k} , alias r_{N3} , needed to balance the bridge varies directly with R_1 , which in this type of unit obviously varies a lot. It can be ganged with R_{1b} and the voltage range switch; a rather elaborate device which may incline one more favourably to a stabilized negative source. This balance is rendered ineffective for hum and other rapid fluctuations by the capacitor across R_1 . A balancing capacitor across R_{N3} would have to be very large, and in practice it has been found better to apply most of the available capacitance in the hum filter. Some is useful across N3, however, to suppress random noise.

Since the fluctuations in the

unstabilized negative source correspond only partially with those in the main supply, adjustment of r_{N3} is not very effective for neutralizing R_i and still less r_{1a} . Fig. 10 can be applied successfully, but Figs. 11 and 12 (Part 2) are not directly applicable. Hogg has suggested a modified form in which R_7 is inserted in the negative main supply as before, while in place of R_2 there is a potential divider across the negative source. The parallel resistance of the two resistors composing it must be equal to R_2 , and their individual values such as to apply the correct standing V_{2g1} . Changes of V_{R7} are thus passed to the control grid, but R_7 has to be several times greater than in Fig. 11 to allow for the step-down in potential. Moreover the current to be supplied by the negative source is considerably increased. It was considered that these drawbacks were not outweighed by the advantage of separate current feedback, especially as Fig. 10 can be adjusted to do the same thing more simply, though at some slight loss of mains voltage stabilization.

Connecting the heater of V2 to cathode was found to introduce about 10 mV of hum, which could be avoided by transferring it to the zero volts line. If N3 has a tendency to go out when V_o is adjusted towards zero it is because the anode of V2 is "bottoming," causing I_{2g2} to increase sharply. The tendency can be reduced by increasing I_{N3} or preferably by removing the cause such as by reducing V_i or increasing R_5 .

The procedure for calculating resistance values, etc., is the same as for Fig. 7. The grid bias scheme calls for no comment, except to point out that the outlets are not to be used for supplying appreciable current.

The voltage range switch ought, of course, to be capable of safely handling the high voltages, up to about 1750 V peak, across the transformer outers. One of the old-fashioned "anti-capacity" types, slightly modified to increase the leakage paths, has been found satisfactory.

It can be seen from all this that the facility of voltage control below 100-200 V necessitates considerable elaboration of the unit and reduces the possibilities of obtaining a high degree of stabilization. By accepting some restriction on the output current and the regulation, one or more output voltages, variable down to zero, can be obtained quite simply as additions to the main highly-stabilized output. This device is the subject of an article to follow.

APPENDIX

Fig. A shows the theoretical circuit of a stabilizing unit of the type considered, and Fig. B relates the quantities shown to a current/voltage diagram such as Fig. 4. Increments of these voltages and currents are denoted by the prefix Δ ; and it must be borne in mind that r_{1a} , m , etc., are by no means constant, and their

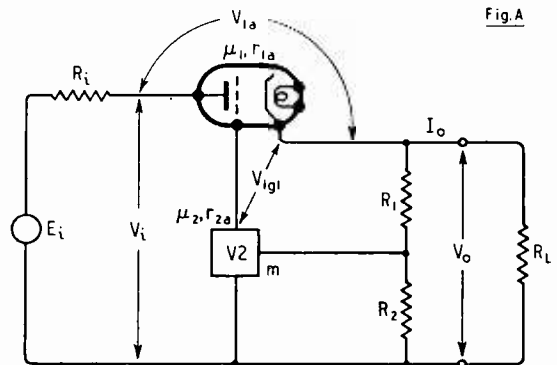

values must be related to the particular working points considered, while if the increments are not infinitesimal the valve parameters must be mean values.

It is assumed that the voltage and current changes are slow enough for reactance to be neglected. Of course the system could be considered more generally by substituting complex impedances for resistances. The results given here do not apply to hum, etc.

Although the sign of equality is used in all the following equations, they are subject to the approximations stated.

The interesting performance characteristics are :

(i) The stabilization ratio, as regards variations in E_i , which may be defined as

$$S' = \frac{\Delta E_i}{\Delta V_0} \quad (R_L \text{ constant}) \quad (1)$$

but for practical purposes it is more useful to consider

$$S = \frac{\Delta E_i / \Delta V_0}{E_i / V_0} = S' \frac{V_0}{E_i} \quad (R_L \text{ constant}) \quad (1a)$$

If R_i is assumed to comprise all causes of regulation, including mains transformer resistance, and E_i is rectified voltage on no load, S represents the ratio by which percentage mains fluctuations are reduced.

(ii) R_0 , the output resistance, defined as

$$R_0 = - \frac{\Delta V_0}{\Delta I_0} \quad (E_i \text{ constant}) \quad (2)$$

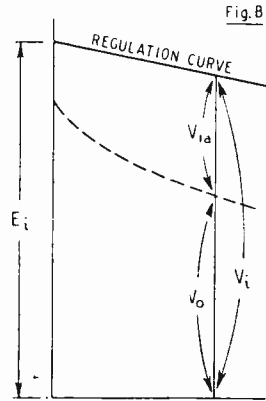

In the following, all current increments through R_i other than ΔI_0 are neglected.

From valve theory

$$\Delta I_0 r_{1a} = \Delta V_{1a} + \mu_1 \Delta V_{1g1}$$

$$\text{Also } \Delta V_{1a} = \Delta E_i - \Delta I_0 R_i - \Delta V_0$$

$$\text{Hence } \Delta I_0 (r_{1a} + R_i) + \Delta V_0 = \Delta E_i + \mu_1 \Delta V_{1g1} \quad (3)$$

Assuming V_2 is a pentode, whose anode current, I_{2a} , is virtually independent of V_{2g1} .

$$\Delta V_{1g1} = \Delta V_{2a(b)} - m(\Delta V_{2g1} - \Delta V_{2k}) - m_2 \Delta V_{2g2} \quad (4)$$

where $V_{2a(b)}$ is the anode feed voltage for V_2 , relative to $+V_0$.

m is the voltage gain of V_2 via its control grid,

m_2 is the voltage gain of V_2 via its screen grid.

By defining the voltage variations of the V_2 electrodes $m(4)$, in terms of E_i , V_0 and I_0 , according to the circuit conditions, and substituting in (3), S' and R_0 can be evaluated.

In the circuit of Fig. 6 and Fig. 7, neglecting r_{n2} in comparison with R_5 ,

$$\begin{aligned} \Delta V_{2a(b)} &= 0 \\ \Delta V_{2g1} &= \beta_0 \Delta V_0 \quad \text{where } \beta_0 = R_2 / (R_1 + R_2) \\ \Delta V_{2k} &= (\Delta E_i - R_2 \Delta I_0) r_{n1} / R_1 \quad (r_{n1} \ll R_{1a} \text{ and } R_{1b}) \\ \Delta V_{2g2} &= (\Delta E_i - R_2 \Delta I_0) R_{1b} / R_4 \end{aligned}$$

$$\text{Substituting in (3) and (4),} \\ \Delta I_0 (r_{1a} + q R_i) + \Delta V_0 (\mu_1 m \beta_0) = E_i q \quad (5a)$$

$$\text{where } q = 1 + \frac{\mu_1 m}{R_4} \left(r_{n1} - \frac{R_{4b}}{\mu_2 g_2} \right)$$

$\mu_2 g_2 = \frac{m}{m_2}$ = amplification factor of V_2 , control grid to screen grid, and t is neglected in comparison with $\mu_1 m \beta_0$.

Substituting this and (1) in (5a), and neglecting $(r_{1a} + q R_i) / R_L$ in comparison with $\mu_1 m \beta_0$,

$$S' = \frac{\mu_1 m \beta_0}{q} \quad (6a)$$

If the cathode and screen-grid potentials of V_2 are constant, $q = 1$, and

$$S' = \mu_1 m \beta_0 \quad (7a)$$

i.e., the stabilization ratio as defined by (1) is equal to the overall gain in the feedback loop.

q can also be made equal to 1 by making

$$R_{4b} = \mu_{2g2} r_{n1} \quad (8a)$$

S' can be made infinitely great by putting $q = 0$, i.e.,

$$R_{4b} = \mu_{2g2} \left(\frac{R_4}{\mu_1 m} + r_{n1} \right) \quad (9a)$$

Also from (2) and (5a), if E_i is constant, so that $\Delta E_i = 0$,

$$R_0 = \frac{r_{1a} + q R_i}{\mu_1 m \beta_0} \quad (10a)$$

If $q = 1$ for either of the reasons given above for (7a) or (8a),

$$R_0 = \frac{r_{1a} + R_i}{\mu_1 m \beta_0} \quad (11a)$$

i.e., the internal resistance of the unit is divided by the stabilization ratio.

If S' is made infinite, as in (9a),

$$R_0 = \frac{r_{1a}}{\mu_1 m \beta_0} \quad (12a)$$

i.e., the source resistance R_i is cancelled by input feedback.

To cancel the valve resistance too and make $R_0 = 0$, put $r_{1a} + q R_i = 0$, i.e.,

$$R_{1b} = \mu_{2g2} \left(\frac{R_1}{\mu_1 m} \cdot \frac{(r_{1a} + R_i)}{R_i} + r_{n1} \right) \quad (13a)$$

in which case

$$S' = - \mu_1 m \beta_0 \cdot \frac{R_i}{r_{1a}} \quad (14a)$$

If V_2 anode is fed from the anode side of V_1 , so that $\Delta V_{2a(b)} = \Delta V_i$ is written in (4), the equations (5a) to (14a), are modified thus, respectively,

$$\begin{aligned} \Delta I_0 [r_{1a} + (q + \mu_1) R_i] + \Delta V_0 (\mu_1 m \beta_0 + \mu_1) \\ = \Delta E_i (q + \mu_1) \quad (5b) \end{aligned}$$

Assuming $m \beta_0 \gg 1$,

$$S' = \frac{\mu_1 m \beta_0}{q + \mu_1} \quad (6b)$$

$$(V_{2g2} \text{ and } V_{2k} \text{ constant}) \quad S' = \frac{\mu_1 m \beta_0}{1 + \mu_1} \quad (7b)$$

i.e., the anode feed condition worsens the stabilization ratio by the divisor $(\mu_1 + 1)$.

$(q + \mu_1)$ can be made equal to 1, restoring the basic stabilization (7a) if

$$R_{1b} = \mu_{2g2} \left(\frac{R_1}{m} + r_{n1} \right) \quad (8b)$$

$$(S' = \infty) \quad R_{1b} = \mu_{2g2} \left(\frac{R_1 (\mu_1 + 1)}{\mu_1 m} + r_{n1} \right) \quad (9b)$$

$$R_0 = \frac{r_{1a} + (q + \mu_1) R_i}{\mu_1 m \beta_0} \quad (10b)$$

If $q = 1$,

$$R_0 = \frac{r_{1a} + (\mu_1 + 1) R_i}{\mu_1 m \beta_0} \quad (11b)$$

i.e., the anode feed condition multiplies the apparent source resistance by $(\mu_1 + 1)$.

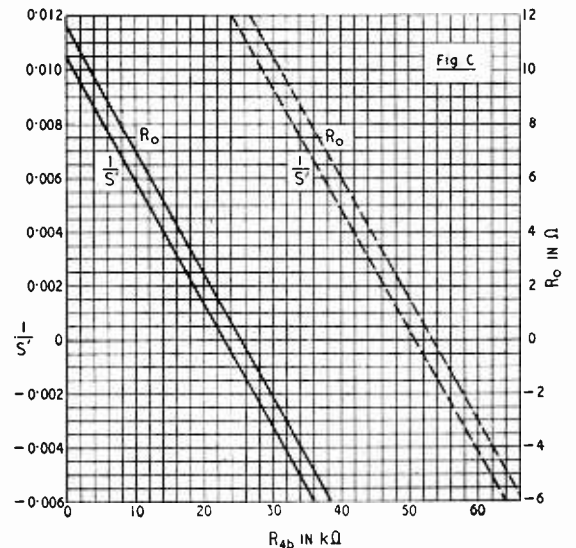

Stabilized Power Supplies—

$$(S' = \infty) \quad R_0 = \frac{r_{1a}}{\mu_1 m p_0} \quad \dots \quad (12b)$$

which is the same as (12a).

$$(R_0 = 0) \quad R_{4b} = \mu_{2g2} \left[\frac{R_1}{\mu_1 m} \cdot \frac{[r_{1a} + R_i(\mu_1 + 1)]}{R_i} + 1 \right] \quad \dots \quad (13b)$$

In practice this may be excessively large

$$(R_0 = 0) \quad S' = -\mu_1 m p_0 \frac{R_i}{r_{1a}} \quad \dots \quad (14b)$$

as in (14a).

In Fig. C, R_0 and $1/S'$ are plotted against R_{1b} for the following typical circuit values, similar to those in Fig. 7 :

- $R_i = 1k\Omega$
- $r_{1a} = 0.7k\Omega$
- $r_{n1} = 0.3k\Omega$
- $R_1 = 120k\Omega$
- $\mu_1 = 8$
- μ_{2g2} (effective) = 65
- $m = 280$
- $p_0 = 0.28$

With the anode of V_2 fed from a constant-potential point as in Fig. 7, the following results are shown :

Value of R_{4b}	R_0	S'
0 kΩ	4.3 times normal, due to r_{n1}	0.15 times normal, due to r_{n1}
19.5	Normal (2.7Ω); r_{n1} neutralized.	Normal (630); r_{n1} neutralized.
23.0	0.41 times normal; R_i neutralized.	∞ Perfect stabn. against ΔE_i
24.0	0.23 times normal; r_{1a} partly neutralized.	- 3.2 times normal; slightly over-stbd.
25.5	0; ($r_{1a} + R_i$) neutd.	- 1.43 times normal
26.5	- 0.185 times normal	- 1 times normal
31.2	- 1 times normal	- 0.42 times normal
With the anode of V_2 fed from	V_i (dotted lines) :	
0	9 times normal	0.068 times normal
19.5	5.7 times normal	0.011 times normal
50.7	0.41 times normal	∞
53.2	0	- 1.43 times normal

Input Voltage Compensation

The relevant part of Fig. 9 can be represented by the network Fig. D. Assuming $R_6 \gg R_2$

$$\Delta V_{2g1} = p_0 \Delta V_0 + p_0 \frac{R_1}{R_6} \Delta V_i = p_0 \Delta V_0 + p_i \Delta V_i \quad (15)$$

where $p_i = \frac{R_1 R_2}{R_1 + R_2} / R_6$

Regarding $V_{2a(b)}$, V_{2k} and V_{2g2} in Fig. 9 as constant, so that $\Delta V_{1g1} = -m \Delta V_{2g1}$, and substituting in (3) and neglecting i in comparison with $\mu_1 m p_0$,

$$\Delta I_0 (r_{1a} + tR_i) + \Delta V_0 (\mu_1 m p_0) = \Delta E_i t \quad \dots \quad (5c)$$

of the same form as (5a) except that $t = (1 - \mu_1 m p_i)$ takes the place of q , i/R_6 appearing in a similar role to R_{4b} , but the influence of r_{n1} is of course absent. Results corresponding to (6a), etc., follow, thus

$$S' = \frac{\mu_1 m p_0}{t} \quad \dots \quad (6c)$$

$$(S' = \infty) \quad R_6 = \mu_1 m p_0 R_1 \quad \dots \quad (9c)$$

$$R_0 = \frac{r_{1a} + tR_i}{\mu_1 m p_0} \quad \dots \quad (10c)$$

$$(S' = \infty) \quad R_0 = \frac{r_{1a}}{\mu_1 m p_0} \quad \dots \quad (12c), \text{ same as (12a)}$$

$$(R_0 = 0) \quad R_6 = \mu_1 m p_0 R_1 \frac{R_i}{r_{1a} + R_i} \quad \dots \quad (13c)$$

$$(R_0 = 0) \quad S' = -\mu_1 m p_0 \frac{R_i}{r_{1a}} \quad (14c), \text{ same as (14a)}$$

Output Current Compensation

In Fig. 11, V_i is reduced by the amount $I_0 R_7$ and V_{2g1} by $I_0 R_7 \frac{R_1}{R_1 + R_2}$.

Extending (5c) accordingly,

$$\Delta I_0 \left[r_{1a} + tR_i + R_7 \left(t - \mu_1 m \frac{R_1}{R_1 + R_2} \right) \right] + \Delta V_0 (\mu_1 m p_0) = \Delta E_i t \quad \dots \quad (5d)$$

Putting $t = 0$ for optimum voltage compensation ($S' = \infty$),

$$R_0 = \frac{r_{1a}}{\mu_1 m p_0} - R_7 \frac{R_1}{R_2} \quad \dots \quad (12d)$$

So R_0 can be made zero at the same time as $S' = \infty$ by

$$R_7 = \frac{r_{1a}}{\mu_1 m p_0} \cdot \frac{R_2}{R_1} = \frac{R_1 + R_2}{g_{1m} m R_1} \quad (16)$$

If no voltage compensation, so $t = 1$, R_0 is made zero (but S' negative) by

$$R_7 = \frac{(r_{1a} + R_i)}{\mu_1 m p_0} \cdot \frac{R_2}{R_1} \quad \dots \quad (13d)$$

Equalization of Compensation

In Fig. 10, to fulfil the required conditions,

$$(i) \quad \frac{R_{6a} R_{6b}}{R_{6a} + R_{6b}} = R_6 = \mu_1 m p_0 R_1$$

$$(ii) \quad \frac{R_{6a}}{R_{6b}} = \frac{R_{1a}}{R_2}$$

Solving, with $R_{1b} = 0$,

$$\left. \begin{aligned} R_{6a} &= \mu_1 m R_{1a} \\ R_{6b} &= \mu_1 m R_2 \end{aligned} \right\} \quad \dots \quad (17)$$

Condition (ii) ensures condition (i) for any value of R_{1b} . In Fig. 12, conditions are similar to those in Fig. 10 except that feedback is taken from across R_7 instead of across r_{1a} .

The values of R_{8a} and R_{8b} are therefore

$$\left. \begin{aligned} R_{8a} &= \mu_1 m R_{1a} \frac{R_7}{r_{1a}} = g_{1m} m R_{1a} R_7 \\ R_{8b} &= \mu_1 m R_2 \frac{R_7}{r_{1a}} = g_{1m} m R_2 R_7 \end{aligned} \right\} \quad \dots \quad (18)$$

"NOTES ON SOLDERING"

THIS new 88-page edition of the Tin Research Institute's handbook is intended primarily for industrial users of solders of various kinds but is useful to many others. Mass-production soldering methods are dealt with at some length and special emphasis is laid on an important point that is too often overlooked: parts that are to be joined by soldering should be so designed as to facilitate the making of good, sound joints. The book describes both the theory and the practice of many kinds of soldering. There is a most useful section (illustrated by 8 good photographs) on wiped joints in lead pipes, the successful making of which is perhaps the most satisfying of soldering achievements. Another section shows how to solder such "difficult" metals as stainless steel, cast iron and aluminium. The best fluxes for use on both straightforward and difficult metals are given and the writer is careful to state which of them are or are not permissible in electrical work. Altogether, this is an extremely valuable little book; it is obtainable free of charge from The Tin Research Institute, Fraser Rd., Greenford, Middlesex. R. W. H

ECONOMICAL 50-WATT AMPLIFIER

Taking Advantage of New Ratings for the KT66 Valve

By G. R. WOODVILLE (M.-O. Valve Company)

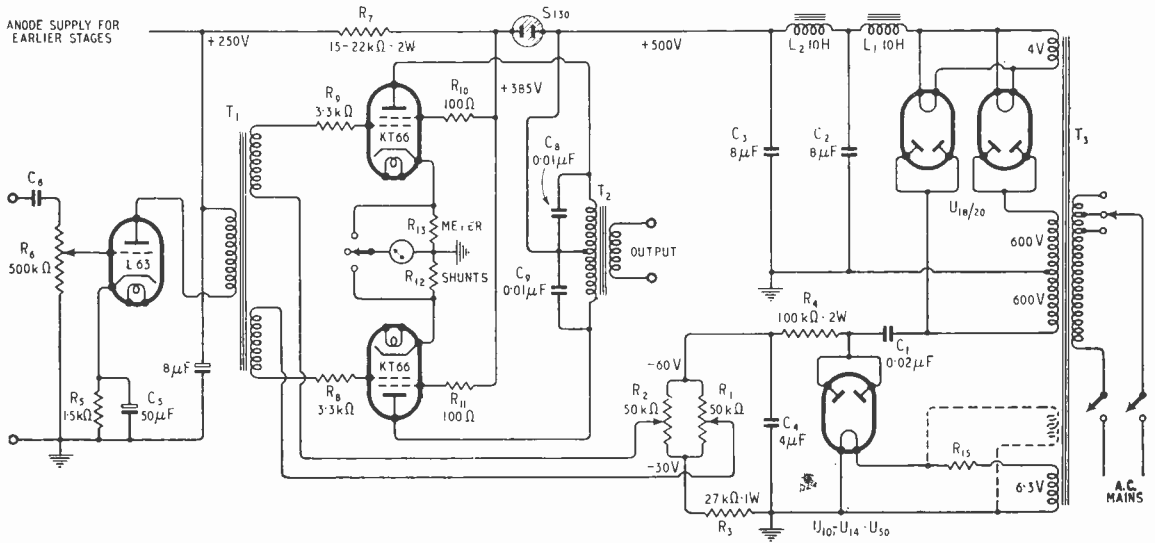

Fig. 1. Complete circuit diagram of 50-watt amplifier using KT66 output valves with fixed bias.

WHEN the KT66 valve was first introduced in 1937 it was given maximum anode and screen voltage ratings of 400 and 300 respectively. At these voltages a pair of valves will provide an output of 30 watts with quiescent anode and screen dissipations of 21.5 and 0.75 watts.

Recent investigations have shown that it is permissible to increase the anode and screen voltages to 500 and 400 respectively and the anode dissipation to 25 watts. These new limits permit the design of an economical 50-watt amplifier. This output represents an increase of nearly 70%, which is obtained with an anode supply voltage only 20% greater than that required for the 30-watt amplifier.

Under the quiescent condition the dissipation is below the permitted maximum, though, due to the regulation of the supply, the voltages are slightly higher than the normal working limit. No ill effects will be experienced from this cause.

The comparative operating con-

ditions per pair of valves unless otherwise stated are :

The circuit used to obtain 50 watts output is shown in Fig. 1, the

		Auto Bias.	Fixed Bias.
H.T. supply voltage...	Q	450	535 V
	FO	425	500 V
Anode voltage ...	Q	415	525 V
	FO	390	480 V
Screen voltage ...	Q	300	420 V
	FO	275	385 V
Anode current ...	Q	104	80 mA
	FO	125	175 mA
Screen current ...	Q	5	3 mA
	FO	18	21 mA
Grid bias per valve ...	—	500 ohms	-45 V (appx.)
Power output ...	—	30	50 W
Anode load resistance ...	—	8,000	6,000 Ω
Anode dissipation per valve ...	Q	21.5	21 W
	FO	9.5	17 W
Screen dissipation per valve ...	Q	0.75	0.6 W
	FO	2.5	4 W
Peak input voltage approx. ...	FO	35+35	45+45 V
R.M.S. voltage to rectifier (approx.) ...	FO	525+525	600+600 V
Efficiency* ...	—	49%	52%

Q = Quiescent or no signal condition.

FO = Full output.

* Efficiency - $\frac{\text{Watts output}}{\text{Watts input to anode and screen}} \times 100$

Some small differences from the above data are to be expected with various pairs of valves.

two KT66 valves being driven from a low-impedance triode via a push-pull transformer T₁. The

Economical 50-watt Amplifier—

latter is not essential since the KT66 valves are not driven into the positive grid current region, and any of the recognized phase-splitting arrangements are suitable, but the D.C. resistance from each KT66 control grid to earth should not greatly exceed 100,000 ohms under the fixed bias conditions.

Independently adjustable bias controls, R_1 , R_2 , provide a bias supply variable from 30 to 60 volts. The bias circuit is somewhat unorthodox in that it is taken from the anode supply transformer T_3 via a small condenser C_1 of high working voltage. The maximum bias voltage obtainable is determined by the capacitance of C_1 and the resistance of R_1 , R_2 , R_3 and R_4 . This arrangement has the advantage that no

put valves are not driven into the positive grid current region. The value of the condenser C_1 may be increased or decreased to provide higher or lower voltages for use with other types of valves. It will be noticed that the rectifier filament is earthed and may be run from the 6.3-volt amplifier heater supply with a resistance R_5 dropping the voltage to 4 or 5 for the rectifier. Suitable resistances values are U_{10} —2.3 ohms, U_{14} —0.9 ohms, and U_{50} —0.65 ohms.

A considerable increase in anode and screen currents takes place with increasing signal input and a low-impedance H.T. supply is required. A choke input filter circuit using two low-resistance chokes L_1 , L_2 , provides a hum-free supply of good regulation. When a small amount of hum can be tolerated at full output, the second choke

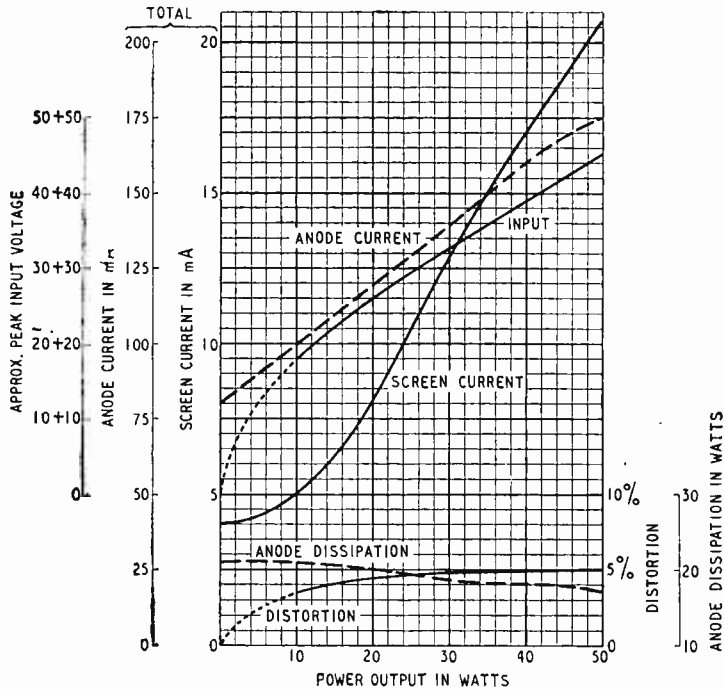

Fig. 2. Performance curves of the amplifier operated in class AB_1 with $V_a=480$, $V_{g2}=385$, $V_{g1}=-45$, and an anode-to-anode load of 6,000 ohms.

special bias transformer is required and that a comparatively low bias voltage (of 60 volts) is obtainable from a high-voltage transformer without the use of resistances dissipating considerable power. This arrangement is suitable whenever a low-impedance bias supply is not required, i.e. when the out-

put valves are not driven into the positive grid current region. The value of the condenser C_1 may be increased or decreased to provide higher or lower voltages for use with other types of valves. It will be noticed that the rectifier filament is earthed and may be run from the 6.3-volt amplifier heater supply with a resistance R_5 dropping the voltage to 4 or 5 for the rectifier. Suitable resistances values are U_{10} —2.3 ohms, U_{14} —0.9 ohms, and U_{50} —0.65 ohms.

A considerable increase in anode and screen currents takes place with increasing signal input and a low-impedance H.T. supply is required. A choke input filter circuit using two low-resistance chokes L_1 , L_2 , provides a hum-free supply of good regulation. When a small amount of hum can be tolerated at full output, the second choke

OUR COVER

The overall size of the chassis of the Pye B18T television receiver, in which the makers have dispensed with a mains transformer, is little bigger than a standard broadcast set. By using an inclined chassis the 9-in C.R.T. has been accommodated in a minimum of space.

not change materially with varying current, the screens are maintained at approximately 115 volts below the anode supply under all conditions of operation. This reduced voltage is also used to supply the earlier valves. The screen grids must not be connected directly to the 500 volt supply.

The meter shunts R_{12} , R_{13} are permanently connected in the cathode circuits of the KT66 valves and the meter measures the total cathode current of each output valve. The quiescent screen current (approx. 1.5 mA) is small compared to the anode current (approx. 40 mA), and may be safely ignored when adjusting the bias voltages by means of the resistances R_1 , R_2 . The actual quiescent current is not important and any value between 30 and 40 mA may be used. At lower currents "crossover" distortion becomes evident and at higher currents the anode dissipation is increased unnecessarily. Both valves must of course be set to identical quiescent currents. A meter having a full-scale deflection with its shunts, of 100/150 mA is suitable.

The performance of the amplifier is illustrated by the curves of Fig. 2, and is suitable for small public address equipment and also makes an economical modulator for low power transmitters, being capable of providing 100% modulation for a 100-watt carrier. It has a high efficiency and a lower quiescent dissipation than many other 50-watt amplifiers. The use of fixed grid bias instead of the more usual cathode bias arrangement renders the amplifier rather less foolproof, and a meter is essential for adjusting the anode current and should preferably be built into the equipment. However, it is not essential that it should have a high accuracy and one of the miniature type is suitable.

INVISIBLE COMPONENTS

THE ability to think out intricate problems mentally, without external aids such as written or drawn symbols, is given to only a few great intellects. Most of us are obliged to lean rather heavily on such aids, though perhaps we do not always realize how well they serve us. If you want to get some idea of how much you owe to our system of numerals, for example, try working out a simple little "sum" in Roman figures, say, dividing MCMXI by XCI.

What the Circuit Diagram Fails to Show

By "CATHODE RAY"

diagram. A year or so ago* I showed how circuits that appear to be unorthodox or even inexplicable can be accounted for in this way. Many—perhaps most—of the snags that so often crop up in new arrangements or modifications can be traced to the "invisible components." Out of sight, out of mind.

Even when aware of their existence, one is often tempted to regard them vaguely as "capacity effects," and either fail to adopt suitable precautions in the right places or go to a lot of trouble to apply them in unnecessary places.

One of the first places where "capacity effects" became well known was at the aerial lead-in. As long as a quarter of a century ago books and articles for

aerial lead can be wired all over the house in lead-covered cable, even, without much loss of signal. The explanation, of course, lies in the impedance across which the stray capacitance occurs. A "stray" amounting to 100 pF, at 1 Mc/s, is a reactance of about 1600Ω. In Fig. 1(a) the input impedance of the receiver is probably tens of kilohms; in (b) perhaps only a few tens of ohms. So the effect of shunting 1600Ω across is likely to be disastrous to (a) and unnoticeable with (b).

As interest developed in the direction of higher frequencies, amateurs naturally became more conscious of "capacity effects" than ever. And rightly so, seeing that the shunting effect of a capacitance is directly proportional to frequency. It would never have occurred to those who rely on second-hand generalizations, therefore, to invent the coaxial cable, with its many pF per foot, for these very high frequencies. "A little knowledge" would have rejected such a proposal scornfully, as obviously having far too much "stray capacity." Fuller knowledge took account of another hidden component—distributed inductance—and found

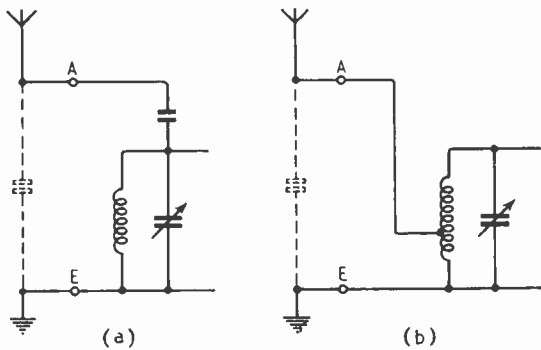

Fig. 1. General rules about "lead-in capacity" that apply to the customary receiver input circuit (a) may not hold good with the alternative arrangement, (b).

The circuit diagram is another example of a practically indispensable aid to thought; simple and effective. But the very effectiveness of such aids creates a danger; the danger of handing over to them too much of our reasoning powers.

When some piece of circuitry behaves unexpectedly, it is usual to place the circuit diagram on the desk in front of us and gaze at it intently, trying to arrive at a plausible explanation of the action in terms of what we see. But it is a great mistake to assume that because a correctly drawn diagram, complete with values of components and any other necessary data, tells the truth, it tells the whole truth and nothing but the truth.

Workers in megacycles are, of course, familiar with the importance of such unrevealed details as inter-electrode capacitances. Sometimes they dot them into the

wireless amateurs were emphasizing the importance of keeping the aerial lead-in well away from walls—and still more from pipes and gutters—and as short as possible, to prevent a large stray capacity to earth bypassing away the precious R.F. currents that were so much needed in those days of low-power transmitters and crystal detectors. With the type of input circuit commonly used (Fig. 1a), that was sound advice. One had only to grasp the aerial lead and notice how signal strength fell off to demonstrate its truth. But it was one of those generalizations which, if accepted blindly, might mislead. Some receivers used the tapped-down input connection (Fig. 1b), sometimes with only a turn or two between aerial and earth terminals; and such sets are almost immune from "capacity effects." The

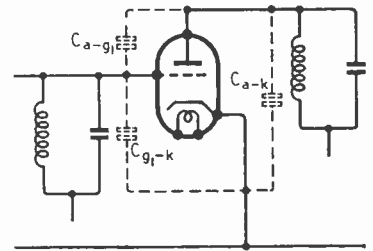

Fig. 2. In a R.F. amplifier the "hidden components" (dotted) are quite as important as many of those shown in the usual circuit diagram.

that this exactly neutralized the effect of the distributed capacitance.

A valuable accomplishment, then, is the ability to estimate

*"Tuning Circuits—Obvious and Otherwise," *Wireless World*, November, 1947.

Invisible Components—

the values of the uncharted quantities and calculate their probable effects in the circuit. In a stage of tuned R.F. amplification one would not normally connect a capacitor between the "live" sides of the input and output.

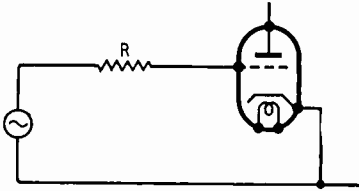

Fig. 3. Another circuit in which valve capacitance may play an important part.

But it has long been common knowledge that one exists, in the form of the anode-to-grid capacitance of the valve (denoted by C_{a-g1} ; Fig. 2). The screen-grid valve was invented to reduce it to a minimum; and then it became necessary to look carefully to the capacitance of the valve holder and the wiring. Even 0.01pF could make all the difference. At the same time, much larger capacitances can be tolerated across input and output (namely, C_{g1-k} and C_{a-k}), because they are neutralized by the tuning inductance and simply necessitate a reduction in tuning capacitance. Ultimately, however, the possible gain at a given frequency—especially a very high frequency—is limited by these input and output capacitances; gain is approximately proportional to coupling impedance, which in a tuned cir-

cuit is $\frac{L}{rC}$ so inversely proportional to C .

It is quite wrong to suppose that such effects are confined to radio frequencies. The "invisible components" can sometimes dominate the situation at audio or even power frequencies. It is well known that when a high resistance (R in Fig. 3) is used in a grid circuit, the fact that the valve is biased and operated to avoid grid current does not exclude voltage drop in R . One must take account of the valve input capacitance, which combines with R to form a potential divider that progressively reduces the overall gain of the stage as signal frequency is increased.

Part of this hidden capacitance is doubly hidden; because in addition to the fairly straightforward C_{g1-k} there is C_{a-g1} , which is by no means straightforward, for the "geometrical" or "cold" capacitance is multiplied by the gain of the valve ("Miller effect"), and in a high- μ triode may amount to several hundred pF.

An interesting example of how stray capacitance can cause serious trouble, even at the lowest frequencies, occurred in a piece of apparatus where the cathode potential of a cathode-follower valve was adjustable over a range of several hundred volts. The valve makers generally refuse to answer for the consequences if the potential between cathode and heater is increased beyond 100V ; sometimes even less. At the same time they recommend that the resistance between them should not exceed, say, $20,000\Omega$. So the heater could neither be joined to a fixed potential nor left floating, and it was therefore necessary to connect the heater to cathode. Since the

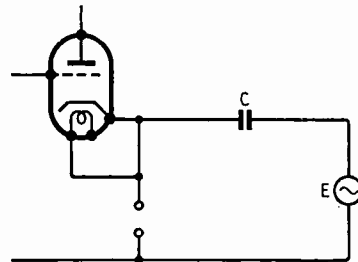

Fig. 4. Example in which a stray capacitance may be vital even in a zero-frequency power unit.

apparatus was designed to give only a D.C. output at the cathode, it might have been supposed that "capacity effects" could be ignored, and precautions confined to making sure that the separate heater winding for this valve was well insulated to stand the full range of voltage. In practice, however, a very unsatisfactory result might have been obtained. The power transformer had another winding supplying about 700V . If the heater winding had been laid on top of it, the circuit would have been equivalent to Fig. 4, where E is 700V , 50c/s , and C is the capacitance between the two transformer windings. Being a

cathode follower, the valve would have an output resistance something less than $1/g_m$; assuming g_m to be in the region of 5mA/V , that would be 200Ω . C might be in the region of 100pF ; at 50c/s , 100pF is about $30\text{M}\Omega$, which seems large enough to be harmless. Yet assuming these figures, the hum voltage in the output would be about 5mV , which is more than five times larger than there was reason to expect it to be from other causes.

But the position was likely to be very much worse. If the output terminals were open-circuited, g_m would be zero, and there would be little to stop the "hum" rocketing up to hundreds of volts!

A capacitor across the output terminals would have to be $50\mu\text{F}$ or more to be much good; excessively bulky and expensive for up to 500V working! The proper solution, of course, was to cut out C by carefully screening the winding. An alternative—to balance out the hum by capacitance to a point in opposite phase—is in principle and in practice less satisfactory. It is better to avoid undesirable effects by getting rid of the cause than by balancing them out with arrangements that require critical adjustment and may leave substantial "residuals."

The term "residuals" is a cue to dilate on the extreme importance of the invisible components in A.C. bridges. But dealing with them is a special art and far too long a story to tell here. So I go on to say a few words about the more relevant problem of "earthing," in the sense of "tying down" parts of the circuit that one wants to have at constant potential. Decoupling, and such like. This too can be made quite a long story, and I only give an example of the sort of thing.

Suppose you have a high-gain amplifier. One of the most important requirements in its design is to prevent it from picking up stray fields. The usual methods are either to build it on a metal chassis, with suitable metal screens for the more vulnerable parts, or to enclose the whole amplifier in a screen; in either case the metalwork is intended to be earthed. If the common negative lines of the circuit can be connected to this metalwork it

simplifies matters to do so. But sometimes it is not; perhaps because there is a necessity to connect it to a point at a different potential to earth. If so, there may be trouble. Fig. 5 represents, say, the input to the first stage, which, of course, is the most sensitive part of the amplifier, so the grid lead has a screen round it (shown dotted) connected to the earthed chassis. Suppose now the common negative lead is connected to some other equipment. Even if the other equipment is also earthed, the leads between the two units or between them and earth may pick up a trace of hum or other interference. This can be represented as a small alternating voltage between the two terminals in Fig. 5; and it is easy to see that it is applied, via the capacitance between grid lead and screen, across the grid resistor, and therefore right in at the front door of the amplifier.

So one often has to think rather hard to decide whether screens should be connected to the "earthy" side of the circuit, or to chassis, or what.

Up to now we have been concentrating mainly on the effects of hidden capacitors. But the possibility of stray "pick-up," just referred to, is a reminder that transformers, too, are hidden in most circuits; often in unsuspected places. One is apt to assume that the alternating magnetic field in a mains or audio transformer is confined to the iron core; but that is very far from true, especially of those chokes and output transformers whose cores are interrupted by gaps.

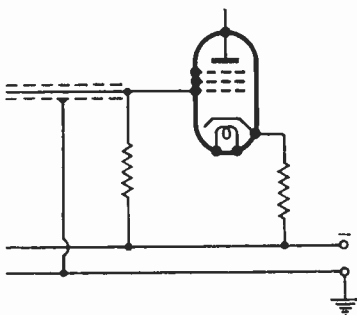

Fig. 5. A common dilemma; should the screening be joined to chassis or "common negative"? Similar problems are particularly prominent in bridge design.

Any leads within a foot or two must be regarded as loosely-coupled turns on the transformer, and although the voltage generated in them may be small it can be very troublesome when highly amplified. P. J. Baxandall showed, in the February, 1947, issue, how careful one has to be about the loop formed by the input lead to an amplifier, the valve itself, and the return.

Another thing one tends to forget when studying a circuit diagram is that there is no perfect insulator, so there is a conduct-

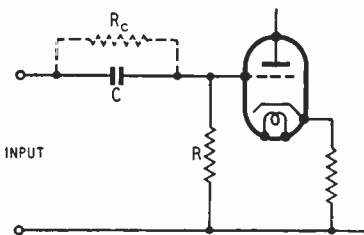

Fig. 6. The leakage, shown here as R_c , may be serious in a valve voltmeter or amplifier.

ance between every pair of points in the circuit! In most places the unintentional conductance is so small as to have no appreciable effect; for example, it may come across a relatively low intentional conductance. Or the effect may be appreciable—for example, the leakage of electrolytic capacitors—but harmless or even slightly beneficial. There are some danger points to look out for, however; one of the most important is a coupling or blocking capacitor in front of a high-resistance circuit. Consider the input to a valve voltmeter (Fig. 6). In order to avoid loading the circuit being measured, R may be made very large, perhaps $50\text{M}\Omega$; but call it only $10\text{M}\Omega$. C will generally have to be fairly large in order to cause no appreciable error in reading at low frequencies, say 25c/s . And it may be there for the purpose of enabling alternating voltages to be measured in the presence of a relatively large direct voltage, say up to 1,000. Even if the instrument is only moderately sensitive it may well be desirable to limit leakage of this unidirectional voltage to, say, 0.01 V. Considering R and the leakage of C (call it R_c) as a resistive potential-divider, then, R, must be not less

INTERFERENCE SUPPRESSION



In the event of the Wireless Telegraphy Bill announced in the House of Commons on October 29th becoming law, it will be necessary to suppress any electrical plant radiating interference.

Every radio and electrical dealer should be in a position to meet the heavy demand that will arise. The condenser filter illustrated is available from stock, list price 27/6.

ANTIFERRENT LIMITED

67 BRYANSTON ST., LONDON, W.1

Invisible Components—

than a million megohms. Which means that no ordinary capacitor will do.

Although this effect is generally less acute in an ordinary amplifier, neglect of it may lead to unexpectedly large anode currents and distortion.

We have seen that small stray mutual inductances may be important even at the lowest frequencies. Self-inductances can generally be neglected at audio frequencies, but not at very high radio frequencies. It is easy to draw a bypass capacitor in a circuit diagram and think you have "earthed" that part of the circuit; but what about the inductance of the leads? What you really have is not Fig. 7(a), as in the diagram, but Fig. 7(b), which is a low impedance at only one frequency. Increasing the capacitance may actually increase the impedance at the working frequency. The best policy is to reduce L as much as possible; the "bushing" types of bypass capacitor are the most familiar

expression of that policy. A good deal of ingenuity has been used in devising still more nearly perfect E.H.F. "seals."*

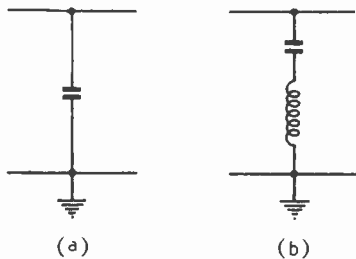

Fig. 7. What is shown as (a) on a E.H.F. circuit diagram is likely to behave more like what would be represented as (b).

Another place where invisible "coils" are a major problem is inside a valve. The inductance of the connections is a principal factor limiting the frequency at which the valve can be effectively used. While the usual simple symbol for a valve is good enough for most audio and moderate radio

* *c.g.*: "The Duct Capacitor," Alan Watton, Jr., *Proc. I.R.E.*, April, 1948, p. 550.

frequency purposes, it is seriously misleading at E.H.F. unless replaced by quite a complicated "circuit diagram."

The general conclusion, then, is a resolve to cultivate the habit of considering what "hidden components" may have to be taken into account under the conditions that apply. This may not always be easy, especially when the quantities in question are distributed around the circuit instead of being conveniently localized or lumped as the standard circuit symbols represent. On the other hand, some problems of this kind that seem at first sight vague or difficult can often be successfully treated as an "equivalent circuit." The common "transmission line" is a classical example. The intervalve transformer is another; Terman in his "Radio Engineering" shows very clearly how it can be treated as three simple equivalent circuits, valid respectively at low, middle, and high audio frequencies. And there are plenty of other examples "in the literature."

NEW DOMESTIC RECEIVERS

A NEW "Ambassador" radio-gramophone Model 4756, Type S, with storage space for 150 records has been introduced by R. N. Fitton, Hutchinson Lane, Brighouse, Yorks. The A.C./D.C. superhet (4 valves+rectifier) covers six wavebands with bandspread tuning between 9.4 and 50 metres. The walnut cabinet measures 33in x 18in x 15½in and the price is £59 15s including tax.

A built-in loop aerial designed for efficient short-wave reception is a feature of the new Ekco "Consolette" A.C./D.C. transportable. The four-valve plus rectifier superhet circuit is housed in a two-colour plastic cabinet with finger-tip side controls for tuning and volume. The price is £17 17s including tax, and the makers are E. K. Cole, South-end-on-Sea.

In the new Model 91G radiogramophone made by Invicta Radio, Parkhurst Road, London, N.7, a seven-valve circuit (plus C.R. tuning indicator) covers short waves (with bandspread tuning) from 11 to 60 metres in addition to the usual medium and long waves. Individual calibrated bandspread tuning scales are provided for the 16, 19, 25 and 31 metre bands. A push-pull output stage delivers 6 watts undis-

torted. There is an automatic record changer and storage space for records in the cabinet which measures 40in x 30in x 21in. The instrument is designed for A.C. mains 110-250V, 40-100 c/s, and the price is £120 2s 5d, including tax.

Bandspread tuning on short-waves and a C.R. tuning indicator are features of the K.B. Model DR20 receiver. This is a superhet with

cluding tax and an A.C./D.C. version including a barretter is also available.

Negative feedback on the pickup circuit is an unusual feature of the K.B. Models DR10 and DR15 which are A.C. and universal mains versions of a new superhet using an 8-inch speaker in a shallow large-area cabinet. The price is £19 10s including tax and the makers are

Kolster Brandes, Footscray, Sidcup, Kent.

The Model 848 "Town and Country" receiver made by Rainbow Radio, Mincing Lane, Blackburn, Lancs, can be operated either from A.C. mains, or from a 6-volt accumulator, H.T. being provided through the medium of a vibrator. The set covers medium waves and 9.8 to 98 metres in three short-wave ranges. An R.F. stage precedes the frequency changer and a separate electron-coupled oscillator is employed. The 10-inch loudspeaker is fed by a push-pull output stage; with mains operations the output is 7 watts and on batteries, 4 watts. Power consumption is 42 watts on mains or 27 watts (4.5 A at 6 V) from batteries.

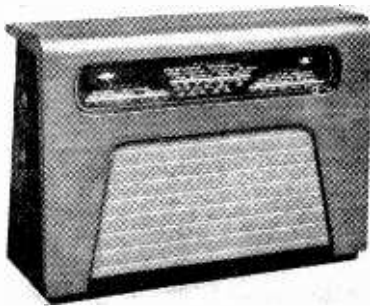

The K.B. Model DR10

four valve and a rectifier. The output valve is rated at 4 watts and there is an 8-inch P.M. loudspeaker. The price is £26 2s 6d in-

SHORT-WAVE CONDITIONS

October in Retrospect : Forecast for December

By T. W. BENNINGTON and L. J. PRECHNER (Engineering Division, B.B.C.)

DURING October, in accordance with the seasonal trend for these latitudes, the average daytime maximum usable frequencies increased very considerably, while the average night-time M.U.F.s decreased somewhat.

Owing to the exceptional amount of ionosphere storminess, daytime working frequencies were rather lower than expected, particularly in the second half of the month. However, long-range working on the 28-Mc/s band was quite frequent, for example with New Zealand, and many contacts were made occasionally on higher frequencies. As is well known, Alexandra Palace television transmissions were received in Cape Town towards the end of October. That this is a long-distance record is due probably to installation of a test television receiver in South Africa, as otherwise it is by no means an unusual distance for propagation of signals of this frequency at the epoch of maximum sunspot activity. Indeed, such results were anticipated in this column's forecasts for October and November. Night-time working frequencies were fairly high for the time of the year.

Sunspot activity in October was less than in September. Two fairly large groups were observed, which crossed the central meridian of the sun on the 17th and 27th.

The month was exceptionally disturbed, particularly so in the last two weeks. Ionospheric storms were observed on 1st-6th, 15th-16th, 18th-24th, 26th-31st, those occurring on 1st, 15th, 19th-21st, 26th-29th and 31st being very violent.

Not very many "Dellinger" fade-outs have been recorded in October, but those on the 9th and 11th were fairly severe.

Forecast.—Daytime M.U.F.s will be probably rather lower in December than in November because of the "midwinter" effect in the Northern Hemisphere. However, daytime working frequencies will be still relatively high, and long-distance communication on very high frequencies should therefore be possible in all directions from this country. The 28-Mc/s amateur band should be regularly usable at suitable times of the day, but conditions on higher frequencies for long-distance contacts will not be as favourable as in November. The night-time M.U.F.s will fall to their lowest values for the winter, so that

the night-time working frequencies will be as low as 7 Mc/s over many long-distance circuits, and they will be in use over longer periods than in November.

Below are given, in terms of the broadcast bands, the working frequencies which should be regularly usable during December for four long-distance circuits running in different directions from this country. (All times are G.M.T.) In addition, a figure in brackets is given for the use of those whose primary interest is the exploitation of certain frequency bands, and this indicates the highest frequency likely to be usable for about 25% of the time.

Montreal :	0000	7Mc/s	(11Mc/s)
	1000	9 "	(12 ")
	1100	11 "	(15 ")
	1200	17 "	(23 ")
	1300	21 "	(27 ")
	1400	26 "	(33 ")
	1700	21 "	(28 ")
	1800	17 "	(24 ")
	1900	15 "	(22 ")
	2000	11 "	(17 ")
2100	9 "	(14 ")	
2300	7 "	(10 ")	
Buenos Aires :	0000	9Mc s	(13Mc/s)
	0400	7 "	(11 ")
	0700	9 "	(16 ")
	0800	15 "	(20 ")
	0900	21 "	(28 ")
	1000	26 "	(32 ")
	1900	17 "	(25 ")
	2000	15 "	(20 ")
	2200	11 "	(16 ")
	2300	9 "	(13 ")
Cape Town :	0000	9Mc/s	(13Mc s)
	0200	7 "	(11 ")
	0600	15 "	(20 ")
	0700	21 "	(32 ")
	0800	26 "	(34 ")
	1500	21 "	(29 ")
	1800	17 "	(25 ")
	2000	15 "	(22 ")
	2100	11 "	(16 ")
	2300	9 "	(13 ")
Chuncking :	0000	7Mc/s	(10Mc/s)
	0500	9 "	(14 ")
	0600	15 "	(21 ")
	0700	17 "	(24 ")
	0800	21 "	(29 ")
	0900	26 "	(33 ")
	1100	21 "	(27 ")
	1200	15 "	(19 ")
	1300	11 "	(15 ")
	1500	9 "	(12 ")
1700	7 "	(10 ")	

Ionosphere storms are not very frequent in December, but if they do occur during periods of darkness they are very troublesome on account of the already very low ionization prevailing during the winter night. At the time of writing it would appear that such disturbances are more likely to occur within the periods 4th-5th, 8th-12th, 16th-17th, 19th-21st, 27th-28th and 31st, than on the other days of the month.

New
TRIX
Quality
SOUND EQUIPMENT

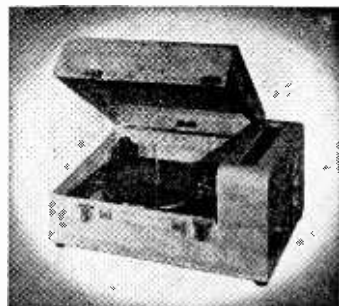

"TRIXETTE"
Automatic Model
PORTABLE
ELECTRIC
GRAMOPHONE

This instrument is fitted with the latest type Garrard Automatic Record Changer which operates with ten 10in. or 12in. records. Magnetic pick-up, first-class amplification and a 6½in. dia. high-efficiency loud-speaker provide excellent quality of reproduction with adequate volume.

Volume and tone controls are provided and the whole unit is designed to operate on A.C. Mains. The case is covered in best quality leather cloth with rubber feet and rust-proofed fittings. All components are tropicalised.

As an alternative there is a Single record player instead of the automatic changer.

Both these models have had an enthusiastic reception in many export markets and are now available in limited quantities for home buyers.

Send for illustrated lists and full details.

THE TRIX ELECTRICAL CO. LTD.
1-5 Maple Place, Tottenham Court Road,
London, W.1. Phone: MUSeum 5817;
Grams & Cables: "Trixadio, Wesdo, London."

AMPLIFIERS · MICROPHONES · LOUDSPEAKERS

Unbiased

By FREE GRID

English as She is Spoke

RADAR is, without doubt, one of the major developments of radio and, apart from its wartime uses, has already proved itself a very present help in trouble to the



Technical phraseology.

fog-encompassed mariner nosing his way cautiously along a crowded estuary amid the raucous bellowings of other ships under way and the bell-ringing bedlam of those lying uneasily at anchor. But it needed a visit to the radar research station at the end of Southend pier to convince me of the real marvels of this new application of radio science. I knew, of course, that I should be able to see on the screen the luminous representation of ships moving over the face of the waters in densest fog, but I little thought that radar would also enable me to see the ghostly forms of stationary and firmly anchored buoys silently and eerily passing up and down on the broad bosom of old Father Thames.

This sort of thing must surely be very bewildering and disconcerting to sailors of the old school, accustomed, as they are, to placing firm reliance on these invaluable aids to navigation to show them the fairway and keep them off the treacherous shoals and sandbanks. Yet they must learn that in this atomic age staid and stately buoys do move up and down stream with all the careless abandon of a woman driver on an arterial road; for one cannot cast doubt upon the categorical statement of a beautifully prepared and elaborately framed series of notices which attempt to instruct the unlettered masses concerning the wonders that they will see when they peer into the what-the-butler-saw type of viewer.

I must confess that I was so incredulous when I first saw the notice that I called the attention of a passing sailor to it. He uttered an astonished "blimey" and followed it up with a graphic description of his opinion couched in phraseology which would, I fear, be too technical to reproduce here. As it is I can only quote the actual words of the notice and leave it to you radar experts to explain matters gently to me: "Additional bright lights that you see on the screen and which do not appear on the [adjoining] chart are ships, buoys and other traffic moving up and down the Thames."

I cannot help thinking that A. P. Herbert, who is an old sailor himself and has written such an excellent account of the wartime history of Southend pier, might have realized what a dreadful shock this new idea of moving buoys would be to us old shellbacks and have broken it to us in a less brusque manner. Perhaps, too, he might have felt the same irritation as I did at the use of the totally unnecessary word "sited" used in another notice which refers to the apparatus "sited on the roof." What a word! even if it *was* used by Herbert Spencer and so is in the *O.E.D.*

Things to Come

THE Editor and I have always set our faces against the adoption by the authorities of any systems of broadcasting, such as the so-called wired-wireless or carrier-current methods, whereby listeners would be denied the freedom of the ether and be compelled to listen to piped programmes, no matter whether they were to their liking or not. I am sorry, therefore, to see a writer in a prominent newspaper talking of the possibility of high-level deliberations on, among other things, "the control of the receiving range of [television] sets manufactured for sale to the public."

Such a control of receiver range would, of course, be impossible unless the public were compelled to buy a television *volksempfänger* in a sealed box which it would be *verboten* to open. If such a thing did happen, let me say at once that I should immediately take to the Cave of Adullam and proceed to make "maquis" receivers with joyous abandon. I hope many *W.W.* readers would join me, not with the idea of making money

(perish the thought!) but of preserving the nation's freedom to listen to and look at anything that was ether-borne.

Apparently all the fuss has arisen because the old idea of using a central cinema to feed programmes to a chain of satellites equipped with big-screen television is a stage nearer practical realization. This newspaper correspondent seems to think that pirate cinemas not belonging to the chain might pick up the programmes and profit thereby. Surely, however, the big cinema interests have enough money and technical talent at their disposal to obviate this sort of thing by means of an efficient "scrambling" system.

The next thing which apparently disturbs the same writer is the thought that home viewers might attempt to pick up the programmes. In this case he is not only disturbed by the thought that they might pirate the cinema transmissions but that the programmes which they filched might not be in good taste. So our moral rectitude, which is not sufficient to prevent our stealing entertainment, is to be protected against being offended by picking up a film of doubtful moral tone. He overlooks the fact that we could in any case see it at the local cinema. The price of this protection is to be a restricted-range receiver, or in other words, a Hitlerian *volksempfänger*.

As for the idea of distributing films by television, I personally look forward to the day when they will be sent out from a central transmitter, not for local cinemas, but for the home viewer. I would much prefer to see a film from the comfort of my fireside armchair than to



The local Amatorium.

turn out on a wet night and queue in the rain in the hope of securing a seat, which may or may not be at a suitable viewing angle, in the local Amatorium.

LETTERS TO THE EDITOR

Controversy on Quality Receivers ♦ Distortion and Inter-modulation ♦ Resistor Ratings

High-Level Detection

IN querying the power handling capabilities of the stages in my high-level detection set your correspondent E. F. Good (your Nov. issue) puts forward suggestions that were actually tried by myself and others as long ago as 1934 when you published the first H.L.D. set. At that time I preferred the transformer coupling between the final R.F. stage and the diode because it simplified the design, provided a very convenient means of permitting paraphrasing from a single diode, and seemed to admit of greater stability on the R.F. side. During the intervening years I have not found that there is anything to be gained by varying my original circuit.

I have not tried an EF55 in the third R.F. stage and use the Osram KT61 because I have found it entirely satisfactory. If instruments are adequate indicators, this valve is more than capable of fully loading the PX25s but I agree that 120 volts RF is on the high side. Normally the output demanded from the KTT61 is not more than 30 to 50 volts as, operating the FX25s with 400V on the anodes and 600 ohm bias resistors, the maximum input (grid to grid) is 76V for the full 15 watts output.

It is pertinent to say here that the set on which I am now working is more in line with standardized practice in that six-volt Osram KT66s (triode connected) are in the output stage. The operating conditions for these are almost identical with those of the PX25s.

Concerning feedback. I quite agree with Mr. Good. In using a small amount of negative feedback I was bowing to the conventions of some of my friends who ought to know more about it than I do. When trying out a new speaker and using an output transformer without a feedback winding I found that there was some increase in the top note response and, as is well known, there was a decrease in the required voltage across the grids of the output valves which would naturally result in lessening the danger of overloading the KT61.

Kensington. W. MACLANACHAN.

Direct-coupled Amplifiers

I SHOULD be most grateful if you could find sufficient space in an early issue of the *Wireless World* to

publish this reply to P. J. Baxandall's letter in your October, 1948, issue.

I am in a position to answer P. J. Baxandall's query as to the conditions of comparison between N. Bonavia Hunt's direct-coupled amplifier and other modern P.P. amplifiers.

Comparisons have been made by me (on a twin L.S. system using a folded bass horn and high-note diffuser for which the makers claim a smooth response from 40 c/s to 20,000 c/s) with a P.P. amplifier using tetrodes with feedback on the lines of P. J. B.'s amplifier (*W.W.*, Jan., 1948) and a Williamson amplifier (*W.W.*, May, 1947). Both these were preceded by a tone control circuit of similar characteristics to N.B.H.'s.

A quick switch over was arranged and several enthusiasts have all agreed that for complete absence of any form of distortion, separation of parts, and extreme clarity, the N. B. H. amplifier could be picked out every time.

The potentiometer referred to is not, as pointed out, part of the tone control network, but used as a pre-set load in connection with the 5k Ω resistor in the cathode of the *6AV6* to ensure that the correct current is passed. Although as a matter of convenience I am using an amplifier of P. J. B. pattern, I think it is most unfair to try to deter enthusiasts who are prepared to go to any lengths to obtain the best possible solution to this complex business of Hi-Fidelity.

F. ASTIN.

Chorley, Lancs.

N. BONAVIA HUNT'S direct-coupled amplifier is only a link at the end of a long chain of amplifiers used by the B.B.C. from microphone to transmitting aerial. He would do well to ponder the fact that as far as he is concerned the only D.C. amplifier in the complete chain to his loudspeaker is Mr. Hunt's.

I have no desire, nor is there need, to prove theoretically that a capacitance can deal with alternating currents of complex wave-form with adequate fidelity; but, if capacitors have not this property, the B.B.C. are transmitting sounds of inferior quality, which of course they sometimes do, due I am sure entirely to other considerations.

Perhaps Mr. Hunt would be kind enough to divulge the secrets of his loudspeaker system which can with

M. WILSON LTD

NEWS!

A

DUAL RANGE TELEVISION RECEIVER

Manual Tuning Control for LONDON or BIRMINGHAM

Superheterodyne principle. 12 Standard Octal Valves. 9" Magnetic Picture Tube (Black and White).

This is the lowest priced Television Receiver available

in Great Britain

Supplies limited at the moment. Further particulars re demonstration, price, delivery, etc., on application.

OUR AIM!

To help bring Television into every Home

ALSO

A MIDGET BATTERY SUPERHETERODYNE 4-VALVE (Button Type) RECEIVER

Medium and Short Waves. 2½" P.M. Speaker. Size 4½" x 5½" x 4". In black crackle case.

Further particulars as above.

SPECIAL

COMPLETE AUDIO FREQUENCY FILTER UNIT

with attenuator control and adjustable iron core, for use with infinite impedance detectors on all High Fidelity Radio circuits. Cuts out whistles. Small, Screened, Colour coded.

Price 15/- with circuit.

307, HIGH HOLBORN, LONDON W.C.1. Phone: HOLborn 4631

Letters to the Editor—

so much accuracy reveal on the one hand the perfection of his D.C. amplifier and on the other the defects of a well-designed R.C. coupled amplifier with feedback.

In all fairness it could be argued that even distorted programmes should be reproduced with the utmost fidelity, and no doubt Mr. Hunt will continue to use his wasteful D.C. amplifier regardless.

But Sir, is it worth it?

ALEXANDER SHACKMAN.

New Barnet,
Herts.

MAY I be allowed to put forward the following points in reference to Mr. P. J. Baxandall's letter criticizing my amplifier?

(1) The circuit published in the July issue gave only one form of the amplifier, mainly intended for gramophone work.

(2) The potentiometer connected in the grid circuit of the second A.F. valve does not form part of the variable tone control network but is intended to be pre-set to the optimum point and not altered.

(3) A later circuit incorporates a fixed resistance with a choke in series between grid and earth.

(4) A big undistorted wattage output cannot alone guarantee good quality reproduction of orchestral music; this amplifier can do so when using PX45 in the output stage.

(5) Two or three watts is not really a sufficient output for reproducing the lower frequencies without distortion even in a small room.

(6) There is no question as to the excellence of the Williamson and the Baxandall push-pull amplifiers recently described in *Wireless World*. But if used in the average home, tone control filters are desirable for correcting at the lower volume levels.

(7) Following orchestral performances with an orchestral score quickly shows a musical listener like myself how much of the actual playing is lost even with the best amplifiers and loudspeakers. My amplifier was designed for the express purpose of picking up these missing parts, one of the essential conditions of success being the elimination as far as possible of the blocking condenser. On this latter principle I take my stand against all criticism.

N. BONAVIA HUNT.

Stagsden, Bedford.

The correspondence on "High-level Detection" and "Direct-Coupled Amplifiers" must now be closed.—Ed.

Assessing Distortion

IT is remarkable, indeed, what harm one single wrong article can do. In your August issue (p.

299) H. S. Casey advocates the use of A.F. amplifiers with very poor low-frequency performances. I have followed up the sources of this clear disagreement between theory and

linearity (e.g., in a transformer core) is the modulation of middle and high frequencies by low frequencies. A distortion test by the intermodulation method (e.g., 100

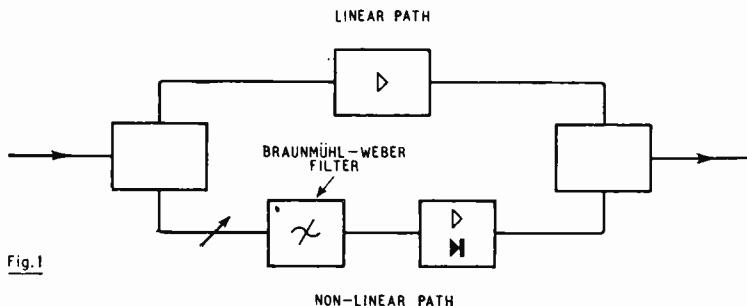

Fig. 1

practice, and your readers may be interested in what I found.

Back in 1936 Dr. Fritz G. Lüchen wrote about "Die nichtlineare Verzerrung in langen Fernsprechkabeln und ihr Einfluss auf die Verständlichkeit der Sprache" (*Telegraphen- und Fernsprechtechnik*, Feb., 1936, p. 27). He used a distorting network consisting of two paths, one linear, and one non-linear, and mixed their outputs to get different amounts of non-linearity. Both paths were independent of frequencies (Fig. 1).

This apparatus is used by Hans Joachim von Braunmühl and Walter Weber. ("Ueber die Stör-

and 2,000 c/s) would measure practically no distortion in an artificial network of Braunmühl and Weber even if it is set for very high non-linearity.

Incidentally this phenomena is taken use of for expanders (Audio Noise Reduction Circuits, Harry F. Olson, *Electronics*, Dec., 1947; p. 118).

So Braunmühl and Weber are wrong, and so is R. E. Jones. (Non-linear Distortion of Music Channels with Particular Reference to the Bristol-Plymouth System, *Post Office Electrical Engineers' Journal*, April, 1939; p. 45); and H. S. Casey seems to be misled by them.

If one wishes to synthesize frequency-dependent non-linearity of the kind encountered in ordinary amplifiers there is another more realistic method (Fig. 2).

Like Braunmühl and Weber we have two paths, one frequency independent and one path with filters that pass frequencies in the band that we want to make non-linear. These frequencies then are caused to modulate the whole complex in the other path. The distortion thus obtained has a good correlation to the second-order distortion encountered in most kinds of AF apparatus. For the production of third and higher order distortion, non-linear circuits must be inserted in the modulating path.

K. SMITH.

Lidingö, Stockholm,
Sweden.

Resistor Ratings

AS a footnote to the above article in your November issue, the following points may be of interest.

In commercial use a life expectation of some 10,000 hours has to be envisaged, whereas Service requirements merely call for a minimum of 1,000 hours at the present time, which has a large bearing on the relatively high wattage ratings at

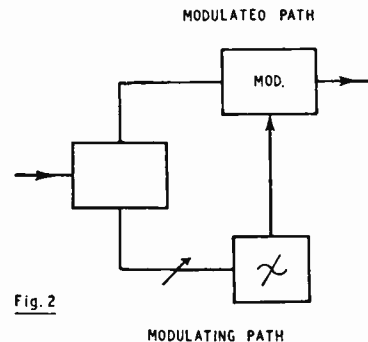

Fig. 2

fähigkeit nichtlinearen Verzerrungen," *Akustische Zeitschrift*, May, 1937; p. 135) for the production of distortion dependent of frequency. This is done by inserting octave filters in the non-linear path in advance of the distorting network. However, such an artificial distortion bears almost no correlation to the distortion encountered in an ordinary amplifier. If, for instance, the band 70-140 c/s is passed through the non-linear path, intermodulation will occur only between frequencies within this band. But we all know that the most disturbing effect of low frequency non-

71°C. assigned to the resistors by the Services.

In addition, it is understood that tests recently carried out indicate that some increase in maximum voltage ratings is possible in the case of the high-stability type.

A. E. BENNETT,
Chief Engineer,

Dubilier Condenser Company.
London, W.3.

Reducing Heater Hum

THE method of reducing heater hum described by Dr. K. G. Britten in your October issue may be satisfactory for a high-gain laboratory amplifier, but has disadvantages for ordinary practical purposes.

For perfect cancellation the hum neutralizing voltage must be in exact antiphase to the hum and of the same amplitude. If the hum which is to be removed is at all large a slight unbalance in either respect will cause a serious increase. In addition the hum introduced by most valves is far from sinusoidal, so that the hum-neutralizing voltage should properly be of a similar waveform, which is difficult to achieve in practice. I would also expect the setting of the controls to alter as the amplifier warmed up.

An alternative to D.C. heating of the early stages, not mentioned in the article, is to supply the heaters from a small R.F. oscillator. As only a few watts are required, this can easily be obtained from a KT61 or KT66 valve in a Hartley circuit, with only a few additional compo-

nents, compared with the bulky equipment of a D.C. power supply. The oscillator can be supplied from the main H.T. line of the amplifier without the necessity for extra rectifiers, chokes and smoothing condensers. The regulation of the oscillator output may not be very good, and if one valve is removed, the heater volts will rise on the remaining valves, but this is not usually a serious objection.

However, with a suitable type of valve in the early stages, and care in the method of earthing, it should be possible to keep the hum in the neighbourhood of the level of the valve and circuit noise without resorting to complications.

Wembley Park, R. TOWNSEND.
Middlesex.

Mercury for Dry Cells

I WOULD like to correct an erroneous impression in the last paragraph of the article "Fresh Progress in Dry Batteries" in your October issue. First, mercury is not scarce; in fact it is very readily available. Secondly, comparatively speaking, mercury is cheap, being the only metal that is today cheaper than pre-war. Mercury in 1939 was £17 per bottle of 76lb, whereas today it is only £15 per bottle.

Of course, red oxide of mercury in a dry battery is not necessarily a cheap raw material.

W. J. TUFFIN,
Manager, Mercury Dept.,
F. W. Berk and Co., Ltd.
London, W.C.

MANUFACTURERS' LITERATURE

Illustrated leaflets giving technical details of the Type 412A pulse generator, Type 1210A frequency meter and photo-electric pick-up, and Type 1250A dynamic balancing machine from Dawe Instruments, 130, Uxbridge Road, Hanwell, London, W.7.

Application Data Book, Issue 3, giving technical details of Type 100 high-stability resistors, etc., from Erie Resistor, Ltd., Carlisle Road, Hendon, London, N.W.9.

Catalogue of W.B. loudspeakers and components, including radio sonde apparatus, from Whitley Electrical Radio, Victoria Street, Mansfield, Notts.

New leaflets dealing with the following products: Ref. SP7/2, Transmitting Valves; Ref. SP8/2, Receiving Valves; Ref. A8, Valve Type DET17; Ref. SL1/2, Receiver Type CR.100/2; Ref. SL4/2, Receiver Type CR.300; Ref. SL17/2, Transmitters: Types TGS and TGM.571; Ref. SL35, Transmitter Type TGM.651; Ref. SL30, AXBT Microphone; Ref. SL37, Airborne Receiver Type AD.86 from Marconi's Wireless Telegraph Co., Marconi House, Chelmsford.

Leaflet giving technical details and dimensions of the Type "A" automatic record changer made by the Plessey Co., Ilford, Essex.

Descriptive lists of transmitters, accessories and components, from Radiocraft, Ltd., 11, Church Road, London, S.E.19.

Standard stock size list of aluminium, brass, copper and other non-ferrous metals from H. Rollett & Co., 6, Chesham Place, London, S.W.1.

Leaflet B/10 describing electronic balancing machines from Scophony, Ltd., Wells, Somerset.

Illustrated catalogue of "Minirack" oscillograph equipment and recording camera, from Southern Instruments, Fernhill, Hawley, Camberley, Surrey.

Illustrated lists of sound amplifying equipment from the Trix Electrical Co., 1-5, Maple Place, Tottenham Court Road, London, W.1.

Illustrated leaflet describing the Hughes supersonic flaw detector, from Henry Hughes & Son, New North Road, Barking, Ilford.

NEW ECONOMICAL A Two-Purpose Loudspeaker which Saves Capital Expenditure



Pat. Applied For.

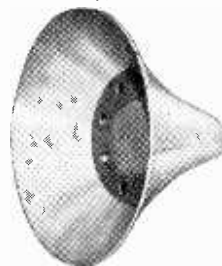

Always there has been the difficulty in many applications, whether the Horn type loudspeaker with its high power possibilities, or the Cone type with its greater frequency range for the same size, is to be used for any particular installation. Both types have their advantages and limits. This new design by F.I. enables the major components of two types to be interchangeable. Main flare, fixing device and assembling nut are common to either of two assemblies. Add centre section and L.S.7. unit for a complete re-entrant horn type 42 REH, or add PAC 6 and special mounting to have a cone and directional baffle system: 42 RC. Whichever type suits you most, you have the opportunity of acquiring the components for the alternative assembly when you are in need of them.

F.I. for P.A.
HORN LOUDSPEAKERS
CONE LOUDSPEAKERS
MICROPHONES

FILM INDUSTRIES LTD.,
60, PADDINGTON STREET, W.1

Telephone: WELbeck 2385

RANDOM RADIATIONS

By "DIALLIST"

A Poser

A WHILE AGO I received from an editor (*not* of this journal) a request for "a short account of the Vipuri tube." Completely floored but feeling that it might be something I ought to know about, I spent a busy morning in searching through text books, encyclopædias and even catalogues and in ringing up erudite friends, all without the slightest success. I was convinced at length that "their ain't no sech thing" (though it looks quite a likely name or doesn't it?)—for something in the electronic line) and that the Vipuri tube which had given me so much hard work was in fact nothing more substantial than a typist's or printer's error; my correspondent had, so to speak, drawn a bow at a Venturi. The "short account," however, must certainly be sent and this is the form it took:

The Vipuri tube, I wrote, was invented by the famous Finnish physicist Konstant Labilius and named by him in honour of his native town, Viipuri. The omission of the second "i" in the name was deliberate and is believed to be a covert allusion to the coccide nature of the invention. The apparatus consists of a glass envelope, 2.00625 metres in length and of inverted-O section, which contains a cathode, an anode, a hyrode, a byrode and eighteen grids, connected in series—paranoia, in a high-pressure vacuum. A length of hoaxial cable, attached to the eastern end of the envelope is provided to form the connection with a source of uni-directional A.C. The purpose which the Vipuri tube is intended to serve is not known.

The Big Black-Out

THE RADIO BLACK-OUT on the evening of November 2nd seems to have been one of the most complete that has ever happened. The North American short-wave stations were just wiped right out and not even the most powerful transmitters could get their messages across to this country. It must have been an exasperating time for those who were trying to get the latest elec-

tion news from the States. These things so often happen at times when you'd give anything for clear reception. I recall the day when Hitler was carrying out his greatest pre-war purge and all communication with Germany was cut off. During the day the only German radio stations working were medium-wavers of moderate power, which were sending out short news bulletins at intervals. I had a communication receiver in use at the time with which I could normally get intelligible daytime reception from one or two of them. But on that day atmospheric were simply maddening.

At Last

THE PROVISIONS OF the new Wireless Telegraphy Bill regarding interference with broadcasting and television reception seem to be just what the doctor ordered so long ago that he must almost have forgotten writing the original prescription. For about a quarter of a century *W.W.* has been urging that the Postmaster General should be given authority to exercise something more than his powers of persuasion on those who operated commercial or domestic electrical apparatus which marred (or even completely wrecked) reception in neighbouring homes. When the bill has become an act, as no doubt it will, the P.M.G. will be able to serve notice on offenders to abate the nuisance within 28 days. He's no longer tied down to polite requests, which too often proved ineffective. Now he can up and at 'em. And that's what I hope he will do. The user of apparatus capable of radiating interference will at last be compelled to make sure that it does not in fact do so. But I've always contended that the real fault probably lay less with the user than with the manufacturer of the apparatus. The ordinary man or woman, for example, who bought an electrical gadget for the home could not be expected to think about its interference-radiating powers. That was an aspect which seldom occurred to his or her non-technical mind. But the manufacturers jolly well did know and one of the queer things is

that some firms making and selling radio or television receivers also made and sold other kinds of domestic apparatus certain to spoil the enjoyment obtainable from these. I profoundly hope that before long people will insure themselves against trouble by refusing to buy apparatus that is not guaranteed to conform to the P.M.G.'s requirements.

Television in the U.S.A.

FROM AMERICAN INDUSTRIAL sources comes the information that the number of television sets now in use in the U.S.A. is over half a million and that it is confidently expected that three times as many as that will be working by the end of next year. I'm told that television is not getting so much into private homes as into bars, hot dog stands, restaurant lounges and so on. The reason given is that the programmes are not often of the kind likely to make a strong appeal to the fireside viewer, but consist too largely of prize fights, race meetings and so on. As there is no receiving licence in the States, and therefore no direct revenue from listeners, all programmes must be provided ultimately by proceeds from advertising. The system works fairly well on the whole so far as "sound" broadcasting is concerned; but there is something of an impasse at the moment in television. Business concerns won't buy "time on the air" from owners of television transmitters until they feel that there are sufficient televisors in the homes of the service area. The owners of these homes, on the other hand, say that they won't buy receivers until they are guaranteed the right kind of programmes. Matters will probably sort themselves out in time.

Metering Programme Appeal

Talking of programmes and their popularity or otherwise reminds me of an account I read recently of a remarkable new method developed in Denmark for ascertaining the number of sets in use in a particular area at any moment. At first blush the method used appears to have a distinctly Heath Robinson touch; but its genuineness and the fact that it works are vouched for by the Journal of the International Broadcasting Organization. The principle

is this. The switching on of a radio receiver connected to an A.C. supply circuit causes a minute distortion of the waveform in the circuit to occur owing to the action of the rectifier in the set. The harmonics resulting from such distortion can be selected and made to appear as a voltage proportional to the number of sets in use. Apply this to a recording voltmeter of suitable type and the result is a graph showing pretty accurately the amount of listening that was being done at any moment. Graphs covering the period from the fourth to the eighth of August this year show, amongst other things, that Copenhagen listeners switched on in large numbers when commentaries on the Olympic Games were being sent out. The system has a good few limitations. It can be used only on A.C. mains and a separate recorder is needed to keep account of events in the circuit served by the output of each transformer station. It does not indicate to what station the sets are tuned. At the same time it should give some very useful information when the records are carefully analysed. One interesting point is that the fact that each recorder deals with only one supply circuit is not altogether a drawback. Such a circuit is likely to serve an area the majority of whose inhabitants are of much the same social type.

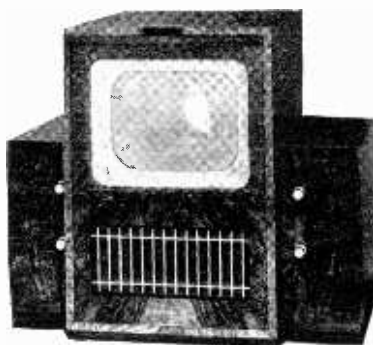

HAYNES RADIO HR88 table-model television receiver with 12-in. tube. The vision channel has six R.F. stages while in the sound channel there is a push-pull triode output stage. An E.H.T. supply of 7 kV is used and the deflector coils, both line and frame, are fed from the time bases without transformers. A table is supplied with the set which together cost £120. plus £26 P.T.

BULGIN SWITCHES

S.400	
S.401	
S.402	
S.403	
S.404	
S.405	

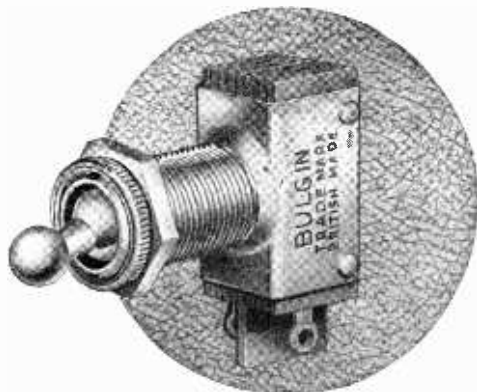

*Every Bulgin Product
Guaranteed*

The already extensive Bulgin Range is now still further increased to a total of *over 400!* These new 'long-bush' Toggle Switches fix by 15/32in. ϕ hole to cabinets, panels, &c. (or to chassis behind thick fronts) of 9/16in. thickness *instead of the standard 3/16in.* A three-fold increase in mounting usefulness.

All types, as listed above, are for 6-250v. \sim circuits, with 3-1A, ratings (based on Unity P.F.) at 250v., or 6-1A, at 6v. Three-times working=test v., and guaranteed life of 25,000 four-a-minute operations, on full load . . . **70 TIMES A DAY FOR A YEAR!**

"The Choice



of Critics"

A. F. BULGIN & Co. Ltd., - BARKING - ESSEX

RECENT INVENTIONS

A Selection of the More Interesting Radio Developments

Large-scale Television

TO avoid restricting the size of the received picture to that of the C.R. tube, it has already been suggested to replace the ordinary fluorescent screen by one having a point-to-point transparency which is controlled by the electron scanning stream. Such a screen could be used to modulate the light passed through it from a powerful lamp, and so project the picture directly upon an external viewing screen.

A screen intended for this purpose is prepared by depositing a thin layer of potassium bromide crystals upon a normally transparent surface in closely set parallel lines to form a diffraction grating, preferable through a wire mask which is subsequently removed. By the so-called Toepler-Schlieren effect, a beam of light projected on to the screen will then suffer diffraction to an extent that varies from zero to a maximum in accordance with the intensity of the scanning stream of electrons. The screen is stated to give a high contrast of light and shade in the projected picture, and to have a sufficiently quick rate of recovery to cope with normal scanning speeds.

Scophony, Ltd.; G. Wikkenhauser; and F. Okolicsanyi. Application date, January 16th, 1945. No. 597580.

Short-wave Aerials

THE so-called slot aerial is formed by cutting out from a conducting sheet or plate an aperture having a length and width determined by the wavelength it is intended to handle. One of its properties is that of polarizing a wave passing in or out of it, so that the electric field of the wave is at right angles to the length of the slot. Conversely, the slot aerial is opaque to waves where the electric field lies parallel with the slot length.

The invention consists in combining these characteristics of the slot aerial with the directional properties of other aerials, such as the wave-guide horn. Various specific aerial embodiments are described showing how the invention can be applied to controlling the frequency and polarization, as well as the relative phase relation and power distribution over the cross-sectional area of a beam of short-wave energy.

H. G. Booker. Application date, October 31st, 1945. No. 600433.

Radar Indicators

THE echo signals returned to a ground observation post by local obstructions, such as buildings and hills, are of large amplitude and wide base. They serve only to clutter-up the near-range end of the time base, and may thus mask the signals from an aircraft that it is desired to detect.

According to the invention, this source of error is reduced by passing the incoming signals through a circuit

which acts as a potentiometer having a logarithmic characteristic, so that the amplitude of strong signals is diminished, whilst that of weak signals is not appreciably affected. As shown, when the strength of the signal applied to the diode V_1 does not exceed 0.3 volts, the impedance of the diode V_2 is so high that the signal is passed, without loss, to the grid of the phasing valve V_4 , and thence to the C.R. indicator. For stronger signals, the impedance of the diode V_2 decreases logarithmically, and the signal voltage is correspondingly attenuated. The diode V_3 is arranged to come into action, as and when V_2 passes beyond

"Clutter" suppression circuit.

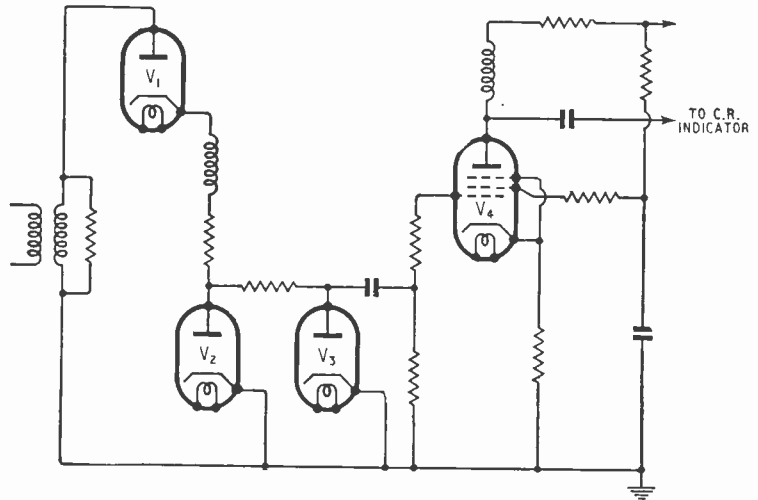

the logarithmic portion of its characteristic curve.

R. H. A. Carter and G. Bradfield. Application date, August 10th, 1945. No. 597912.

Super-regenerative Receivers

THIS type of circuit is very liable to cause interference with neighbouring sets by radiating parasitic oscillations, particularly during the intervals when it is not actually receiving signals.

According to the present invention, the receiver is coupled only intermittently to the aerial, the make-and-break periods being substantially in step with the quenching frequency, though slightly de-phased from it. Preferably the aerial coupling is established at the instant when the oscillations in the regenerative circuits start to build up, and is maintained until their amplitude is almost equal to that

of the incoming signal. The coupling is then broken, and is kept open until the local oscillations are damped out by the quenching valve. In effect, the switching cycle maintains a one-way path, which allows signals from the aerial to reach the receiver, but prevents re-radiation of the locally generated oscillations. The switching is performed by a valve which is controlled by blocking voltages derived from the quenching oscillator through a phasing device.

"Patelhold" Patentverwertungs- and Elektroholding A.G. Convention date (Switzerland), September 11th, 1944. No. 598807.

Panel Mountings

THE usual circular hole bored through the panel of a wireless set to take the spindle of a rheostat or similar control unit is replaced by a slot which is expanded at one end into an aperture of sufficient size to allow the internal component to be with-

drawn bodily, after the external fixing screw for the spindle has first been slackened to permit the necessary sliding movement.

This enables the unit to be conveniently renewed or repaired from outside the panel, and avoids any necessity, say, for inverting a soldering iron inside the chassis. Where two or more similar units are mounted on the same panel, the respective fixing slots should all extend into a common removal aperture.

D. Jackson and Pye, Ltd. Application date, September 27th, 1945. No. 599985.

The British abstracts published here are prepared with the permission of the Controller of H.M. Stationery Office, from specifications obtainable at the Patent Office, 25, Southampton Buildings, London, W.C.2, price 2/- each.

B.B.C. TELEVISION

History of First Public Service

ALL the best accounts of television begin with an early reference to the Nipkow disc, and this article is no exception. Although the present B.B.C. television system is electronic throughout, this has not always been the case.

It was in 1929 that the original Baird system, as it was called, was introduced into the medium-wave broadcast programme for one half-hour daily. The system was a mechanical one, incorporating a Nipkow disc and providing a 30-line picture at $12\frac{1}{2}$ pictures per second. These programmes continued in a desultory fashion until 1935.

They had served their purpose by showing up the inherent low brightness, pronounced flicker and lack of detail inevitably associated with a conventional mechanical scanning system and the only hope of improvement appeared to lie in the adoption of some entirely new principle. Accordingly, in 1931 research was turned towards purely electronic scanning systems. On the receiving side it was decided to use the cathode-ray tube for presentation purposes, since the electron beam could be controlled entirely by voltages and currents. Up to that time, however, the cathode-ray tube had been employed solely for measurement work and considerable development was required to make it suitable for its new function and to evolve a satisfactory scanning system.

CAMERA DEVELOPMENT

For the transmitter, work was proceeding on the electron camera, or Emitron, as it was afterwards designated. This again promised, if successfully developed, to solve the problems of scanning and brightness. The Emitron has a mosaic of thousands of combined photoelectric and capacitive elements which store up the light energy

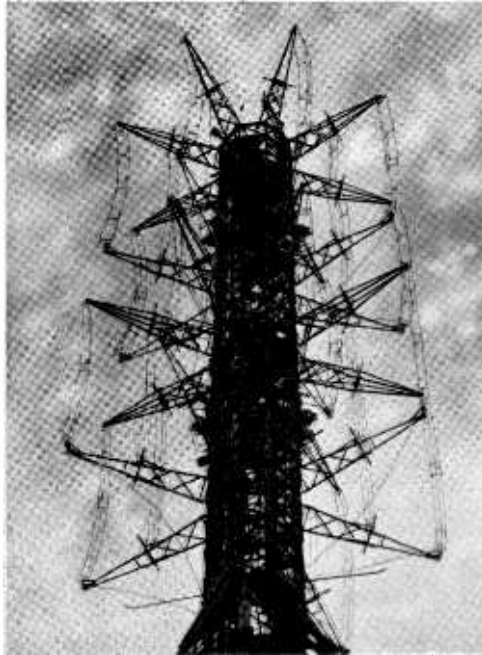

Alexandra Palace television aerials (upper, vision; lower, sound) which, at a height of nearly 200 metres above sea level, dominate North London.

constantly focused on them from the subject. A scanning electron beam discharges each in turn and directs the released energy into a suitable amplifier. The storage principle involved here is as great an advantage as the absence of moving parts. Most of this work was carried out by Electric and Musical Industries, who first of all standardized on 180 lines per picture and 25 pictures per second, but later, to improve detail and reduce flicker still further, changed to the present 405 lines, 50 frames per second interlaced.

Such a scanning system involves over 100,000 elements per picture and calls for a modulation band of at least 2 Mc/s. It had, of course, long been recognized

that any high-definition system could not be accommodated within the medium-wave band and consequently a carrier frequency in the neighbourhood of 40-50 Mc/s was chosen. Such a choice simplified the aerial system required but tended to restrict reception to little more than the horizon. The larger number of elements also involved the design of wide-band video and R.F. amplifiers, none of which had previously been attempted. The Marconi Company collaborated in providing the R.F. transmitter and in consequence the system was known as the Marconi-E.M.I. system.

Meanwhile the Baird Company had been concentrating upon mechanical systems, but some effort was devoted towards the development of the dissector camera and of cathode-ray tubes. This organization also produced an intermediate-film system of transmission. As regards standards, they favoured a 240-line picture and 25 pictures per second, calling for a modulation bandwidth of 1.5 Mc/s.

Another organization which should receive at least brief mention is the Scophony Company. It contributed a wealth of new ideas in television, mainly in connection with cylindrical lenses, high-speed scanning motors, intense light sources and the invention of the Jeffree supersonic light valve, a storage system.

ALEXANDRA PALACE

In the meantime a committee was set up by the Post Office in 1934 to examine the various systems under development and advise on the recommended procedure for inaugurating a television broadcasting service. As a result, it was decided soon afterwards that the B.B.C. should set up a transmitting station at Alexandra Palace, some six miles north of the centre of London and standing 300ft above sea-level.

B.B.C. Television—

In this building would be housed both the Marconi-E.M.I. and the Baird systems for extended trials under strictly comparable conditions. Vision and sound would be radiated at 45 and 41.5 Mc/s respectively.

EARLY TRANSMISSIONS

On completion the aerial system stood 600ft above sea-level, both arrays being mounted on the same mast, the sound just below the vision. The transmitters for the two systems were housed in separate rooms on the ground floor. On the first floor were the two studios, each of 70 x 30-ft floor area, with the vision control equipments located immediately adjacent. The design of these studios followed the technique favoured for film studios both as regards acoustic treatment and lighting. Ventilation, however, proved a major problem owing to the high power needed to provide an average intensity of illumination of some 150-200 ft-candles.

After a preliminary period of operation (August 26th-September 5th) during the 1936 Radiolympia exhibition, when the two systems were used on alternate days, the station went into operation on

November 2nd, 1936, with each system transmitting during alternate weeks. From February, 1937, however, the Marconi-E.M.I. system alone was used, its interlaced scanning with absence of flicker being considered preferable. The normal daily programme averaged about five hours' total broadcasting time and included a considerable variety of subjects, such as plays of all kinds, reviews, dance bands, films, cartoons, discussions, interviews, instructional talks and demonstrations.

It must not be assumed that transmissions were confined solely to these hours or to the Alexandra Palace studios. A balanced R.F. cable network, installed around the centre of London, relayed to the station video signals from television cameras connected to points on the network, either directly or through short lengths of corrected telephone line. This enabled certain functions of national importance and the performances from a limited number of theatres to be televised. In addition, a mobile transmitter, consisting of three large motor vehicles, covered other events taking place within a range of 20 miles of Alexandra Palace. This transmitter operated on 64 Mc/s with an output of 1kW peak.

Finally, long camera cables permitted open-air broadcasts to be carried out in the extensive grounds around the Palace.

The first important outside broadcast was the Coronation in 1937. Later, these broadcasts became more and more frequent with improvement in the Emitron camera and the introduction of the telephoto lens, and in 1938 and 1939 many hours were devoted to the televising of international tennis, test-match cricket and the like.

RECEPTION

Turning briefly to the reception side, it should be mentioned that, whereas the nominal zone was confined to a circle of 25 miles around Alexandra Palace, it was soon discovered that this distance could easily be exceeded and many localities further away than 70 miles were found to enjoy an adequate field strength, particularly where interference was absent. Moreover, few districts throughout the country have not received occasional transmissions during freak atmospheric conditions.

The outbreak of war in 1939 brought this service to an abrupt stop and it was not resumed

again until May 1946. Since that time development work has been mainly concerned with unsensational but steady improvement in quality of transmission and studio technique at Alexandra Palace and in developing the equipment for extending the service to other centres of population. The improvements in the working programme arise from such factors as continually increased sensitivity and freedom from background noise of the Emitron camera

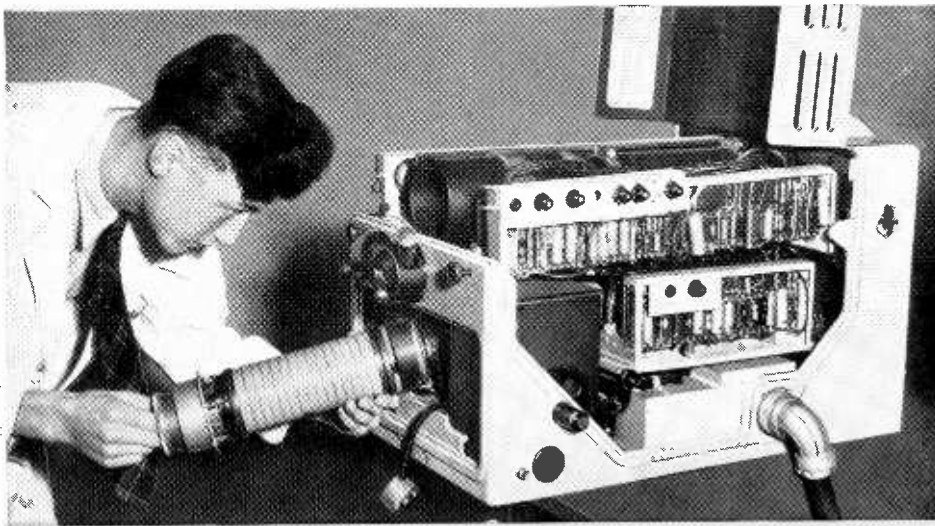

An interior view of the latest addition to the B.B.C.'s television equipment—the C.P.S. Emitron camera developed by E.M.I. Research Laboratories. The tube, which is shown with its scanning coils, is being inserted in the camera; it produces a satisfactory picture in very low lighting intensities.

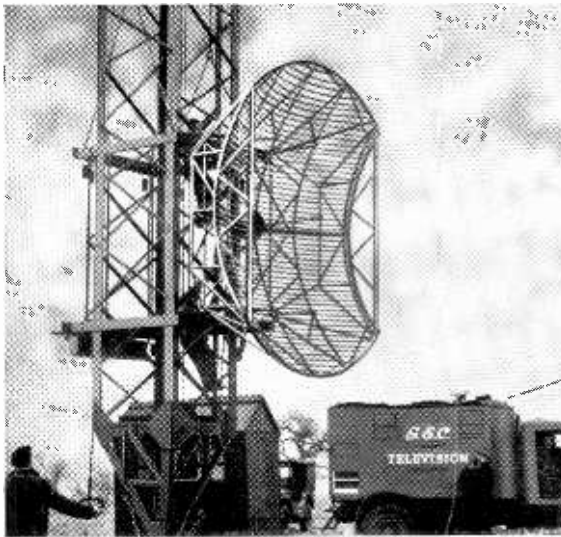

Field tests have been conducted by the G.E.C. preparatory to choosing the sites for the four automatic radio-relay link stations which the company is erecting for the Post Office. They will link the London and, when completed, the Birmingham television stations.

and new ventures in staging, continuity and mixing. A recent example of this was the greater detail and depth of focus obtained with the new C.P.S. Emitron, particularly noticeable in the Olympic Games transmissions.

EXTENDED SERVICE

What lies in the future? The next step is the relay station at Sutton Coldfield, near Birmingham. Work is proceeding on the apparatus and on the relay stations which will form an R.F. link to feed it with programmes originating in London. An alternative link in the form of a wide-band coaxial cable will also be available and will enable direct experience of both methods of relaying to be gained. The station is expected to be in operation in 12 months' time and will serve not only Birmingham but a considerable part of the Midlands. It seems likely that this station will be followed by another in the Newcastle-on-Tyne area.

It is often alleged that improvements in the quality of the television system can be effected by increasing the number of lines used in scanning. In fact, however, in any case where the

programme. At the receiving end the simplification and cheapen-

relaying of programmes over considerable distances is involved, the advantage of more lines is very questionable. From the practical point of view there is much more scope for improvement in other directions. Greater depth of focus in the transmitting cameras, to mention only one, will not only lead to a marked improvement in the picture quality but will remove one restriction upon the producer of a television pro-

gramme. At the receiving end the simplification and cheapen-

ing of the apparatus are of prime importance to the popularity of television. All these things are needed whatever the number of lines, but they are more likely to be achieved in the near future with the present system than with any greater number of lines. Because of this, the B.B.C. has authoritatively stated that no change in the number of lines will be considered for some years. The decision is as justifiable as it is welcome. There will be plenty of time to debate the expediency of such a change when all improvements within the present system have been effected.

A word of praise is due to those who, some thirteen years ago, were responsible for the decisions around which this controversy is to-day centred. At that time these decisions appeared wildly optimistic: now, despite superficial arguments to the contrary, they are proved amazingly correct. It is to be hoped that those authorities who have yet to make their final decisions on this matter will be equally inspired.

MASS PRODUCTION

With the number of British television licence holders increasing by some 5,000 a month receivers are now being mass produced. Moreover, with the extension of the B.B.C. television service to the Midlands towards the end of next year and, within a short time to other thickly populated areas, there will be a continuously growing demand for receivers. This photograph was taken at the H.M.V. factory, Hayes, Middlesex, and shows the wiring of television chassis and the final assembly of sets on parallel production lines.



BRITISH TELEVISION STANDARDS

Technical Characteristics of the 405-line System

THE London Television station (Alexandra Palace) operates at 45 Mc/s (vision) and 41.5 Mc/s (sound) with vertical polarization and powers of 17 kW and 3 kW respectively. Double-sideband transmission is used and positive modulation in the vision channel; that is, 100 per cent modulation corresponds to peak white, 30 per cent to the black level and from 30 per cent to zero is reserved for synchronizing pulses. Modulation frequencies up to 3 Mc/s are radiated.

The Birmingham Television station (Sutton Coldfield) is to operate at 61.75 Mc/s (vision) and 58.25 Mc/s (sound), with powers of 35 kW and 12 kW respectively. The upper sideband of the vision

channel is to be partially suppressed to reduce the total bandwidth. In all other respects the signals are to be the same as those of the London station.

Vision Waveform

There are 405 lines per picture with 25 pictures a second. Interlaced scanning is used to give 202.5 lines per frame and 50 frames a second. The line and frame recurrence frequencies are 10.125 kc/s and 50 c/s respectively. The aspect ratio, horizontal/vertical, is 5/4.

The waveforms are shown in the drawing. Of each line 84.5 per cent is devoted to the picture signal and is followed by 0.5 per cent black level, 10 per cent sync

pulse and 5 per cent black level. The 0.5 per cent black level preceding the sync pulse is included in order to ensure precision of timing of the sync pulse since it ensures that the pulse shall always start from black level. Receiver synchronizing and fly-back can take place in a maximum time equal to the durations of the sync pulse and the following black level (15 per cent of the total line time), and the scan must occupy 85 per cent of the total line time.

The frame pulses are broken at line frequency so that the line time base can be kept in step continuously throughout the frame pulse periods.

The picture signal is interrupted for 14 lines in every frame for synchronizing. In even frames the line and frame pulses coincide, but in odd frames the frame pulse occurs half-way through a line and the second frame pulse coincides with a line pulse.

The frame pulses consist of a series of pulses of 40 per cent of a line duration separated by intervals of 10 per cent of a line. At present 8 pulses are transmitted (4 lines), but the standards permit the use of any number from 6 to 12.

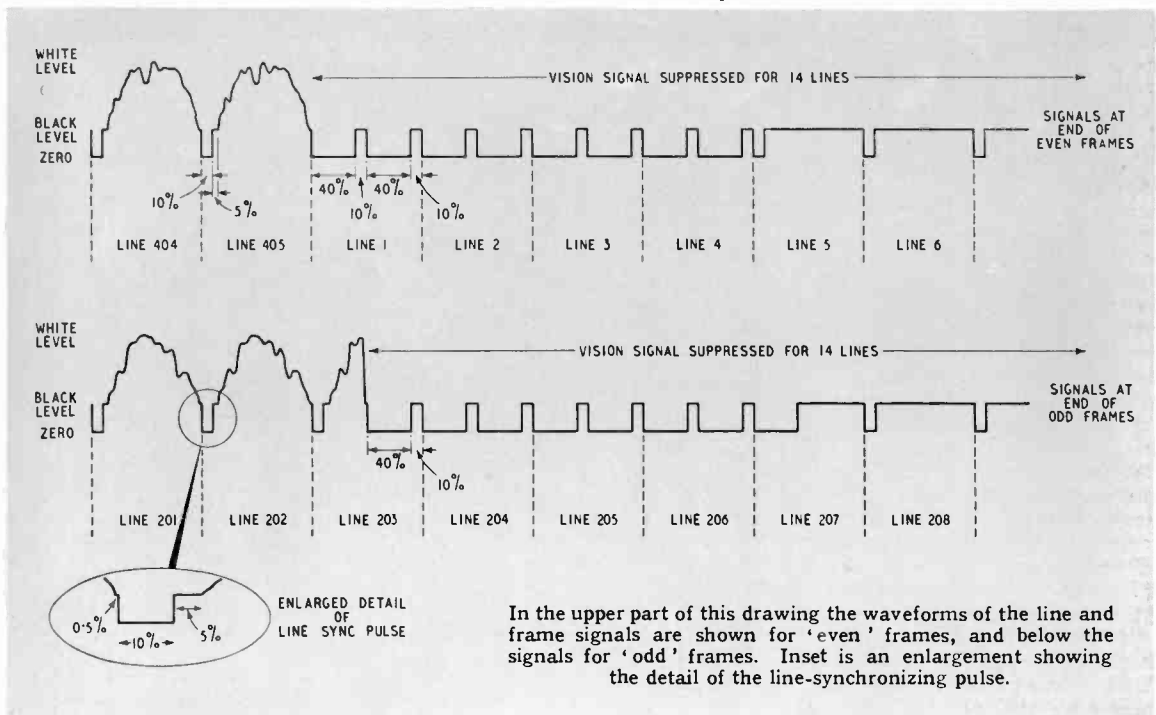

In the upper part of this drawing the waveforms of the line and frame signals are shown for 'even' frames, and below the signals for 'odd' frames. Inset is an enlargement showing the detail of the line-synchronizing pulse.

THE

FETISH OF LINES

Why the 405 Standard is Best

IT is not unusual for early workers in new branches of science to reach conclusions destined later to be proved fallacious. That, after all, is the way in which many of the greatest advances in scientific knowledge are made: a theory is put forward which fits in with all the then

By R. W. HALLOWS,

M.A. Cantab, M.I.E.E.

centuries old—that the Leyden jar and apparatus derived from it condensed charges of electricity.

Television's most unlucky inheritance from the past is the



Courtesy E.M.I.

A good example of the quality of picture obtainable with 405 lines at a distance of some 15 miles from the transmitter (see also p. 8.8). The enlarged reproduction of part of the unretouched photograph shows the line structure.

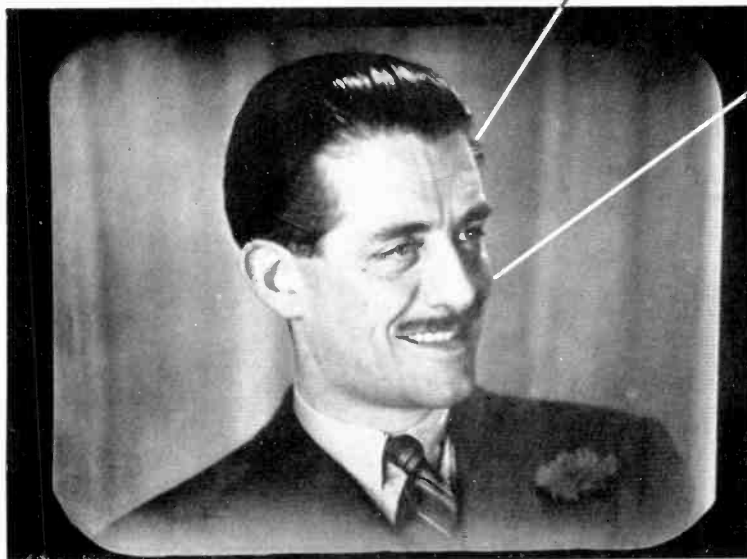

creased in number from 14,550 to 66,600 in eighteen months and that manufacturers of receivers have difficulty in keeping pace with the demand for their wares.

Twenty years ago, when television technique was still very much in its infancy, the number of scanning lines gave a very fair idea of the quality of the image. Had J. L. Baird then been able to transmit 60-line instead of 30-line images, there would have been a considerable improvement in the quality. That his 180-line television, when it came, was vastly better than his 30-line and that the present 405-line system of the B.B.C. is greatly superior to either helped, no doubt, to crystallize the fallacious belief that the 'line' is almost on a footing with the farad, the ohm and the henry as a basic unit—the unit of television definition. How erroneous is any such conception will be realized when it is said that images of poorer definition may result, if the number of scanning lines is increased. The reason for this will appear in a moment.

known facts; it remains the accepted belief unless and until fresh discoveries make it necessary to discard the old theory in favour of a new one. Some erroneous theories, unfortunately, have long lives; and even when they are dead they may leave evil legacies behind them. Like other branches of electricity, television has suffered and still suffers in this way. The student of electricity, brought up on elementary textbooks which make him an inheritor of Benjamin Franklin's two-centuries-old legacy concerning positive currents, must revise all his ideas when he progresses to electronics. It is only quite recently that the adoption of the term capacitor has finally put paid to the idea—again two cen-

belief that the number of scanning lines from which an image on the viewing screen is built up is the sole criterion of the degree of definition provided by a system. This idea is an unconscionable time-a-dying and, though it is to be hoped that two centuries will not be required for its extinction, it is still very much alive to-day. It is, in fact, not uncommon to hear the opinion expressed by people who ought to know better that television can never hope to become really popular until 800-line or 1,000-line definition is introduced. And this despite the fact that television has so far advanced towards real popularity in the area served by Britain's 405-line transmissions that holders of receiving licences have in-

Scanning

As your eye scans a page of *Wireless World*, the letterpress and the illustrations are seen to be sharp and clear. The definition, in a word, is excellent. It is so because the transitions from black to white and vice versa are abrupt and to all appearances in-

The Fetish of Lines—

stantaneous. The speed at which the eye moves over the page is small—not more, probably, than a quarter of a mile an hour; but the scanning spot of the television receiver travels at the rate of several thousand miles an hour over the screen. The spot could change instantaneously from black to white only if it were responding to a modulation impulse of perfectly square waveform. To produce such a waveform it would be necessary for the transmitter to send, and for the receiver to handle faithfully, all harmonics up to infinity. This cannot be done; first, because of the technical difficulties involved and, secondly, because it is necessary to limit the width of the channel allotted to each transmitter. The result is that the change from black to white, or white to black, may be described as taking place gradually: it requires a definite, though small, amount of time.

Lines v. Bandwidth

The B.B.C. 405-line system fully transmits modulation frequencies up to 2.7 Mc/s. This frequency range allows the waveforms corresponding to transients to be reasonably square. It is neither a difficult nor a costly business to make receivers with an adequate response. In a good receiver the time required for the spot to change from black to white with such a frequency range may be 0.1 μ sec. The active scan of each of the 405 lines (excluding the initial black, the final black and the line sync pulse) occupies 83.5 μ sec. During the change, therefore, the spot travels 1/835, or, in round figures, one eight-hundredth of a line. In the 20 x 16 cm image provided by the majority of television receivers to-day this is equivalent to a distance of 0.25 mm. The edges of vertical black lines on a white background are not dead sharp; but the blurring is so slight that the eye of a viewer records no sensation of muzziness.

Now suppose that it is decided to double the number of scanning lines without increasing the range of modulation frequencies. The velocity of the scanning spot over the screen is doubled, for it must cover twice the number of lines of

equal length in each second. The spot now travels the comparatively large distance of 0.5 mm while changing and the eye of the viewer receives the impression of an image containing an appreciable — and unacceptable — amount of blurring. Doubling the lines has reduced the definition horizontally along the lines; it has increased the definition only in the vertical direction.

Then, why not increase the transmitted and received frequency ranges to enable them to cope with the larger number of scanning lines? Put the modulation frequencies up to 5 Mc/s (let us keep to round figures) and all will be well. Or will it? Unfortunately it will not. With twice the number of scanning lines the degree of blurring due to the time needed by the spot to make its changes can be kept at the same level. We are then back to where we were in the horizontal direction. We can obtain the full improvement in both directions only if the range of frequencies is multiplied not by 2 but by 2². Hence, with 811 lines the definition in the horizontal sense could equal that of 405 lines only if the modulation range were increased from 2.7 to 5.4 Mc/s, and the full benefit of 811 lines could be obtained only by increasing the range to 10.8 Mc/s. The transmitted and received bandwidths must be about 1 Mc/s greater than these figures if single-sideband transmission is adopted, but twice these figures if double-sideband operation is used.

Definition

The truth about this definition business is that it involves not one factor, but two. The number of lines sets the standard in one direction only of the scan—the vertical. The degree of definition in the horizontal sense is determined by the range of modulation frequencies transmitted and received. What we may term 'overall definition' depends upon the balance between the number of scanning lines and the range of modulation frequencies. And in that respect the 405-line system, with rather more than a 2.5-Mc/s range of modulation frequencies, seems to have achieved the nearest approach to the golden

mean that has been registered by any system in use in the world.

Practical tests show that, once the number of lines has approached 400, the increase in the frequency range needed to provide a better image is out of all proportion to the increase in the number of scanning lines. An increase in the frequency range accompanying a 405-line transmission to, say, 4 Mc/s gives a better image by improving the horizontal definition; the vertical definition is already adequate. On the other hand, an increase in the number of lines unaccompanied by a corresponding very large increase in the range of frequencies is likely to mean a worse image, owing to the greater amount of blurring that is bound to occur during the horizontal scan.

Receiver Performance

Suppose that we make the number of lines 525; then the all-important horizontal definition will be as good as that of the 405-line system *only* if the range of modulation frequencies approaches $\frac{525}{405} \times 2.7 =$ approx. 3.5 Mc/s. If the modulation band is much below this, or if the receiving set can deal properly with only a narrower band of frequencies, then the received image will be inferior in quality to that provided by a 405-line 2.7-Mc/s service. That this is a fact and no mere matter of theory is amply proved by the opinions expressed by Americans who saw last summer the results obtained by British television in its transmissions of Olympic Games events. With hardly an exception, they were emphatically of opinion that the images on our television screens were clearer and better than those to which they were accustomed in their own country.

I do not know of any television station which transmits modulation frequencies approaching 4 Mc/s. And even were there such a station, how many televisors exist that would do anything like justice to its transmissions? The future of television is inseparably bound up with the ability of manufacturers to market receivers at a price which is within the means of the ordinary man.

(Concluded on page S.7)

The Fetish of Lines—

Mass-production methods can most probably achieve this, provided that the receiver is not called upon to give a more or less level response to frequencies in excess of 2.5 Mc/s. With 405-line transmissions it is, in fact, possible to produce low-priced receivers with a response of 2.0 Mc/s—or even less—which give acceptable images on the viewing screen. With a greater number of lines, and therefore a much wider minimum frequency-band response, the television receiver must always be an expensive piece of apparatus.

Relaying

There are many other considerations in favour of the 405-line system. One of the most important of these is concerned with the problems of relaying. Since metre wavelengths are the longest that can be used, no television transmitter can have a service area with a radius of more than 30-50 miles. This in most countries means that relays are necessary, if more than very small areas are to be covered. For unattended relays, whether connected to the main station by radio link or coaxial cable, a limited frequency range is desirable: the cost of coaxial cable, for instance, goes up by leaps and bounds when the frequency range exceeds 2.5 Mc/s. In establishing relays much use can be made of existing coaxial cables, designed to deal with frequencies up to 2.5 Mc/s; to lay new ones adapted for higher frequencies would involve enormous expense.

Relaying in television is not just a one-way affair. There is no question that outside broadcasts have much more entertainment value than those made from the studio. Hence it is essential that it should be possible to send from considerable distances to the broadcasting centre images which can be re-transmitted from it with acceptable quality. The coaxial cable (if it is conveniently situated) furnishes one means of 'piping' outside items to the studio; a second is provided by the light, mobile equipment, with radio link, which has been developed in Britain. In both cases the present upper frequency limit

is in the neighbourhood of 2.5 Mc/s, and that, as we have seen, means 405-line transmissions if the best is to be got out of it. A third method, pioneered by the B.B.C., enables ordinary telephone lines to be used for distances up to two or three miles. The upper limit of frequencies is here about 2 Mc/s. This provides in a 405-line system up-to-the-minute sporting and other pictures from places far outside the studio. In view of their topical interest the definition is more than merely acceptable; in a 525-line system the horizontal blurring, unavoidably present, would almost certainly render them unacceptable.

I have emphasized the important relationship between the number of scanning lines and the range of modulation frequencies dealt with by both transmitter and receiver. Upon the former depends the definition in the vertical sense only. A reasonably good balance between vertical and horizontal definition has been achieved by the B.B.C. in its 405-line, 2.7-Mc/s transmissions. A marked improvement in the

quality of the received images can be made by retaining the number of scanning lines and increasing the frequency range of both transmitter and receiver. We have, in fact, never yet seen 405-line images as they might be, were both transmitting and receiving equipment brought near to the ideal in frequency response.

Standardization

It has been said that in television there is not, and cannot be, any equivalent of the crystal receiver in radio. That is true—up to a point. Increasing demand may well make it possible in the near future to market at a low price television receivers responding to, perhaps, 2 Mc/s and providing acceptable images. The mass production of such television receivers will be possible only if they are standardized—and could there be a better standard than the 405-line, 2.7-Mc/s system?

I do not believe that there could. No other system can guarantee to those who now purchase television receivers (1) that their sets will furnish good images now; and (2) that they will continue to do so for years to come, no matter what advances are made in the technique of transmission. If and when transmission with a 4-Mc/s range is made, owners of old sets will be no worse off than they were; those who purchase up-to-date television receiving equipment will benefit just as do those who buy the latest in sound broadcast receivers.

Could the 405-line, 2.7-Mc/s system be adopted now as the European standard, progress would be certain and rapid. Britain was the first country in the world to conduct a regular television service. That service has passed through its teething troubles and the data of those who helped to develop it are there for the asking.

There is no reason why television in Europe should not become continent-wide, if only there can be agreement to adopt a common standard of vertical and horizontal definition. And both theory and years of practice show that in achieving a balance between these the 405-line, 2.7-Mc/s system is unsurpassed.



"Pyetron" television camera with rotatable triple-lens turret as used by Pye Ltd. for the demonstration transmissions during the British Exhibition in Copenhagen.



IN spite of the impairment introduced by the photographic and printing processes, it is possible to convey pictorially a good idea of the picture quality of the present B.B.C. television transmissions. The photographs on this page were taken directly off the screen of a standard H.M.V. set which has a fifteen-inch tube giving a 12.5 x 10 in (32 x 25 cm) picture. Another picture, with an enlargement to show line structure, is reproduced on page S.5.

How Good is 405 Lines?

SOME UN-RETOUCHED
PICTURES TAKEN DIRECTLY
FROM A RECEIVER SCREEN

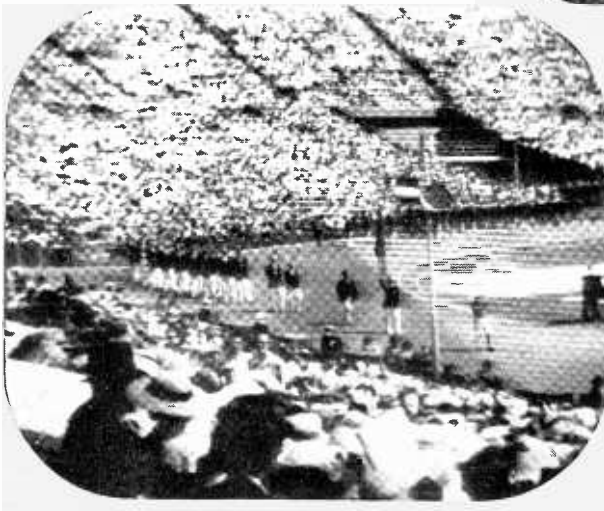

A television camera was set up opposite the Prime Minister's residence in Downing Street, London, for the first time when the Commonwealth Prime Ministers met recently. Viewers received the picture given at the top of the page showing Ministers arriving.

The centre picture, of Leslie Mitchell who is a regular television broadcaster, shows the amount of detail now obtainable in a head-and-shoulders picture.

Viewers were given many hours of programmes from Wembley Stadium and other venues during the Olympic Games. Even with a crowd scene, such as this general view (left) of the march past of competitors at the Stadium, a reasonably good picture is obtained.

LINES versus COST

Economics of Receiver Design

THE cost of a television receiver is affected in two ways by the number of scanning lines. Since the bandwidth needed is proportional to the square of the number of lines, more stages of amplification are needed as the lines are increased. Since the power consumption of the horizontal scanning circuit is proportional to the number of lines with constant tube voltage, or to the square of the number of lines if the tube voltage is varied with the lines to reduce the spot diameter, either more efficient, and therefore more expensive, circuits must be used or the power input and size of valves must be increased.

The effect on stage gain is easy

to assess. Present-day receivers have a gain around 90 db and five stages are commonly used. The average gain per stage is thus 18 db. If more lines are used the reduction of gain per stage is $40 \log(\text{lines}/405)$. For 525 lines, the reduction is 4.5 db and the stage gain becomes 13.5 db, making $90/13.5=6.7$, say, 7 stages necessary. The change is thus likely to add two stages to the receiver; in some cases, one extra stage with more efficient couplings throughout will suffice. Either method obviously increases the cost appreciably.

The effect of the number of lines on the scanning circuits is much more difficult to assess because these circuits, and especially some

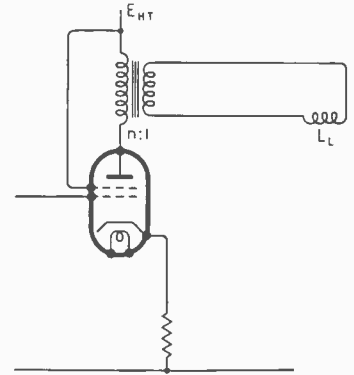
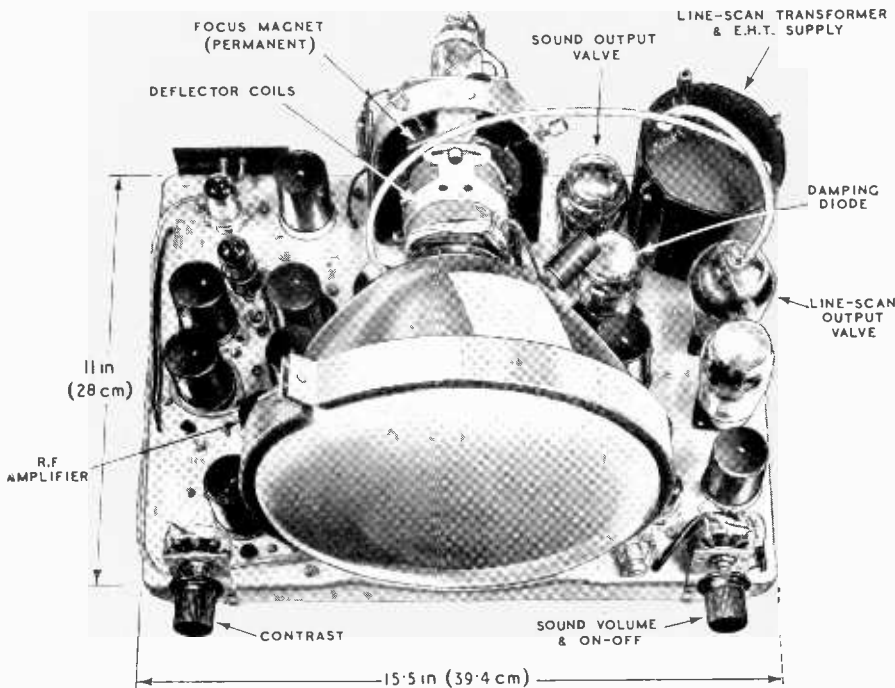

Fig. 1. Typical circuit diagram of simple 'brute force' line-scanning stage with the damping resistance omitted.

of the newer ones, are quite complex. Up to quite recently it has been the standard British practice to use a 'brute force' deflection system. It is one which is exceedingly inefficient on a power basis but which has the great merits of being simple and inexpensive.

The basic circuit is shown in Fig. 1. A tetrode or pentode valve is fed with a sawtooth voltage wave, often generated by a blocking oscillator, and the resulting sawtooth current wave in the anode is fed to the deflector coils L_L through a step-down transformer of ratio $n:1$. Since the inductance L_L together with the relevant transformer inductance forms a resonant circuit with the stray capacitance, heavy damping is needed to prevent

This photograph shows the chassis of the new Pye Br8T receiver. Everything is mounted on it except for the loudspeaker which is attached to the cabinet and connected by a plug and socket



Lines versus Cost—

it from being set into oscillation at its natural frequency. This damping is partly provided by core losses in the transformer, partly by losses in the iron yoke of the deflector coils and partly by a shunt damping resistor. This resistor is not shown in Fig. 1, but is usually connected across the deflector coil, either directly or more often with a series capacitor. It is usually called the Linearity Control and it affects the linearity of the scan on the left-hand side of the picture.

When used with a typical 9-in tube operating at about 5 kV such a time-base output stage takes about 90 mA at 350 V—or 31.5 W. In a typical case the peak-to-peak amplitude of primary current might be 210 mA and the deflector coil current 0.59 A with a transformer having a turns ratio 3.5:1 and an efficiency of 64 per cent. The transformer loss reckoned here is not a direct power loss but comes about through the leakage inductance. There is an optimum relation between the transformer and deflector coil inductance for efficiency,¹ although this does not seem to be widely known. On account of the need for high insulation and low self-capacitance in the transformer it is hard to reduce the leakage inductance sufficiently to make the efficiency better than about 70 per cent.

With a linearly changing current on the scan, the back E.M.F. across the coil is constant, neglecting the second-order effects of series resistance. The back E.M.F. on the anode is about 275 V and acts against the H.T. supply. Throughout the scan the anode potential of the valve is about 75 V only. The anode dissipation is only some 6.75 W and the valve itself works under very efficient conditions.

Fly-back and Overshoot

At the end of the scan the valve is cut off and at the start of the fly-back the circuit is equivalent to an inductance of about 110 mH with a current of 200 mA shunted by a capacitance of some 60 pF charged to 275 V, the whole having a shunt damping resistance.

¹ "Television Receiving Equipment," by W. T. Cocking, 1st Ed. (1940), p. 67. See also, "Television Deflection Circuits," by A. W. Friend, *R.C.A. Review*, March 1947, p. 122.

This resistance is so adjusted that the overshoot of the circuit is about 5 per cent ($Q=0.75$).

During fly-back the current flows into the capacitance, charging it in the opposite sense to its initial charge and to a peak value of about 7.6 times the initial one. The peak voltage on the anode of

valve, the latter is the shunt damping resistor to the deflector coil. In production, large variations of circuit Q can be tolerated, for they affect only the setting of the linearity control. High losses are permissible, or even desirable, and ordinary transformer iron in laminations as thick as 0.02 in is usually quite satisfactory.

Effect of Lines on Power

If the number of lines is increased and made N times as great and the tube voltage is also increased N times, the current in the deflector coil must be increased \sqrt{N} times and the back E.M.F. across it grows by $N^{3/2}$ times. Unless the circuit capacitance can be reduced, which is unlikely, the transformer ratio must be altered from $n:1$ to $n/N:1$ in order to speed up the fly-back sufficiently. With this change in transformer ratio, the primary current is increased $N^{3/2}$ times and the back E.M.F. \sqrt{N} times, calling for nearly the same increase of H.T. voltage.

The latter may be uneconomical and it may be desirable to reduce the ratio still further and keep the H.T. voltage the same. The current is then proportional to N^2 .

With 525 lines, for instance, the current would rise from the 90 mA of the 405-line system to 152 mA. This increase would necessitate the use of two valves in parallel as well as an increase of 62 mA in the H.T. supply.

A possible way of reducing the power needed is to improve the efficiency of the deflector coils. This can be done,² but it entails the use of more expensive laminations for the yoke and a more difficult winding process.

The alternative is to use one of the 'economy' circuits. These invariably require the use of an extra valve, which may be a diode or triode, or even a metal rectifier, additional components and rather more precise control over the circuit elements in production. However, they are in general use in countries where the lines exceed 405 and, as will be shown later, they are coming into use in Britain when particularly

(Continued on page S.11)

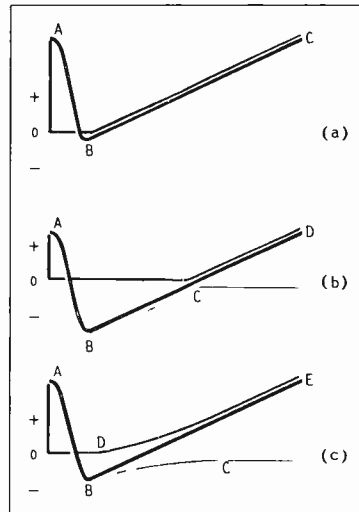

Fig. 2. In the 'brute force' circuit only a small overshoot is permissible and the valve passes current for almost the whole of the scan period as shown at (a). Under ideal conditions in an economy circuit the main valve passes current only for one-half of the scan period and an auxiliary valve provides current from the overshoot during the other half. In practice these ideal conditions (b) cannot be reached and the practical case is nearer (c).

the valve during fly-back is thus this value plus the H.T. voltage, or nearly 2.5 kV in a typical case. It is useful to note that the ratio of peak voltage on fly-back to the back E.M.F. on the scan is remarkably constant with different circuits. It varies from about 7.6 with 5 per cent overshoot to about 8.6 with 90 per cent overshoot. This is, of course, with a fly-back equal to the full period allowed by the British standards.

The great merit of this 'brute force' time-base is that it is not at all critical. The circuit adjustments are 'Width' and 'Linearity.' The former controls the output of the stage and is usually a variable cathode resistor to the

² "Iron-cored Deflecting Coils for Cathode-Ray Tubes," by A. Woroncow, *J. Instn. Elect. Engrs*, 1946, Vol. 93, Part IIIA, No. 10, p. 1564.

ANOTHER



DEVELOPMENT

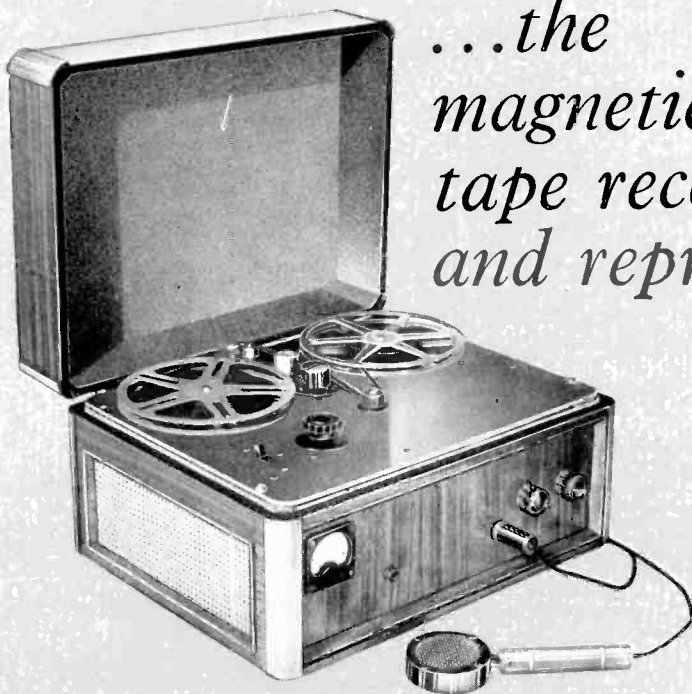

*...the
magnetic
tape recorder
and reproducer*

The applications of the "Wearite" Magnetic Tape Recorder are limited only by human imagination and ingenuity. Direct recordings from radio receivers, recording of speeches, the making of talking books, as an office dictating machine . . . these are just a very few of its uses. Write now for further detailed information.

L'esprit ne conçoit pas de limite aux modes d'emploi de l'enregistreur magnétique sur bande "wearite" grâce auquel on peut faire l'enregistrement directement d'une diffusion à la radio d'un discours, d'une oration, d'une dictée littéraire . . . et ce n'est là qu'une partie de l'usage que l'on peut tirer de l'enregistreur magnétique sur bande "wearite." Nous serons enchantés de vous envoyer tous les renseignements et des détails complets à ce sujet.

Las aplicaciones del Registrador de Cinta Magnético "Wearite" no tienen otros límites que los de la imaginación e inventiva humanas. Las grabaciones hechas directamente de los receptores de radio, el registro de la palabra hablada, la impresión de libros hablados, como aparato ideal para dictar correspondencia . . . son tan sólo unos pocos de sus muchos usos. Escriba ahora para información más completa.

Wright and Weaire Ltd.

138 SLOANE STREET, LONDON, S.W. 1, ENGLAND
Cablegrams: Writewea, London

SOME OTHER



PRODUCTS



Ceramic Switches

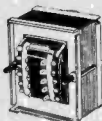

Mains Transformers

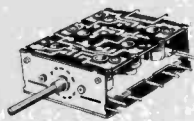

Coil Packs

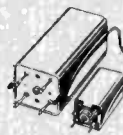

I.F. Transformers

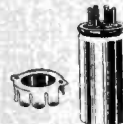

Vibrators

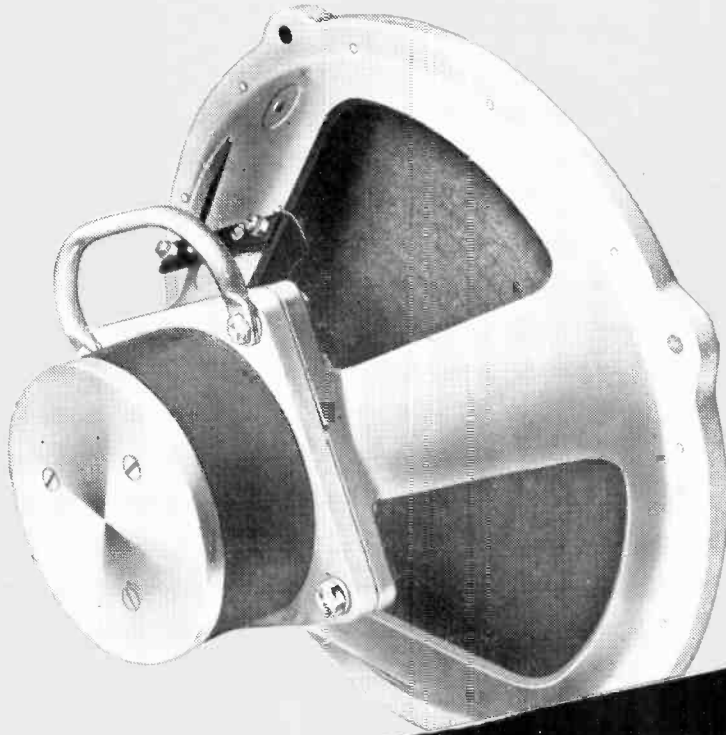

**They speak
for
themselves....**

The SS10A 12-inch Heavy Duty Speaker, illustrated, offering a frequency response from 55 to 11,000 c.p.s. and handling 10 watts is a typical example of TRUVOX workmanship.

Fidelity of response speaks for itself to the discriminating ear. Precision manufacture is no less eloquent to the trained engineer. These qualities are making TRUVOX speakers famous.

TRUVOX

TRUVOX ENGINEERING CO. LTD · EXHIBITION GROUNDS · WEMBLEY · ENG.

Lines vs Cost—

low-voltage operation is required. In Fig. 2 (a) is shown the scanning waveform and the current provided by the valve in the simple circuit of Fig. 1. The valve is in operation for nearly the whole scan period BC and is

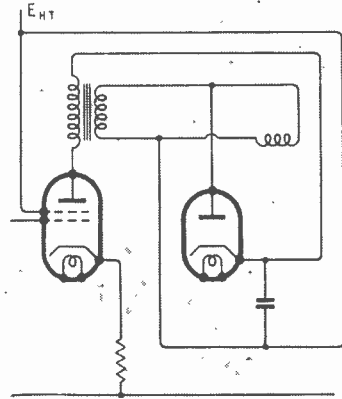

Fig. 3. Simplified diagram of an economy circuit giving both current and voltage saving.

cut off during the fly-back AB and for a very short period after it when the scan current is provided by the 5 per cent overshoot.

Under ideal conditions the economy circuit utilizes much of the energy which is otherwise dissipated during fly-back. With no circuit losses there is 100 per cent overshoot. Over the fly-back period the circuit runs free, and at the end of fly-back an auxiliary valve comes into action to provide heavy damping and to absorb the stored energy of the magnetic field so that the current falls slowly at the correct scanning rate.

Economy Circuit

Referring to Fig. 2 (b) the circuit is free for fly-back from A to B. From B to C the auxiliary valve is in action and the scan current is drawn from the energy stored in the field of the deflector coil. At C this auxiliary valve goes out of action and the main driving valve starts work and provides the remainder of the scan, C to D.

Compared with the 'brute-force' system the valve provides one-half the peak current and is

in action for one-half the time. Its mean current and the power drawn from the H.T. system are, therefore, one quarter. In practice the gain is much less than this. Unless thinner, and therefore more expensive, laminations are used for the iron cores, it is difficult to reduce the losses to a degree which will permit the overshoot to exceed about 50 per cent. The sharp change over between valves which is shown in Fig. 2 (b) is also impracticable. The actual performance has conditions nearer those depicted in Fig. 2 (c).

As before, the circuit is free during fly-back from A to B. The auxiliary valve comes into action and passes a current of the form shown by the curve BC. The main valve starts driving while this auxiliary valve is still conducting and provides the current DE. The sum of the two currents BC and DE gives the scan current BE.

In practice, it is possible to operate this system with about 50 per cent of the power of the 'brute-force' circuit. However, still further economy is possible.¹ The auxiliary valve usually requires a bias which is about

$E_p/n - V_d$ where E_p is the back E.M.F. across the transformer primary on the scan and V_d is the voltage drop across the auxiliary valve. This bias can be built up by the current flowing through the valve into a large capacitor, as in any rectifier circuit. By proper proportioning of the circuit elements this bias voltage can also be used as an additional H.T. source for the driver valve, by connecting it in series with the driver valve.

The basic form of the arrangement is sketched in Fig. 3. It is

¹ "Magnetic-Deflection Circuits for Cathode-Ray Tubes," by Otto H. Schade, *R.C.A. Review*, September 1947, p. 506.

necessary to choose the transformer ratio so that the two valves pass the same mean anode currents and the ratio thus depends on the amount of overshoot. The full details of the circuit cannot be discussed here and the practical circuit is more complex than that of Fig. 3, because it is necessary to compensate for the effects of the series resistance of the deflector coils.

Extra H.T.

It is necessary for the amount of overshoot to be greater than $\sqrt{V_d/E_p}$ if the circuit is to be of any advantage, and it is not of great advantage unless it is considerably greater. The voltage theoretically recoverable is $x^2 E_p - V_d$, where x is the fractional overshoot. With $V_d = 30$ V and $E_p = 275$ V, an extra 39 V is obtained, if $x = 0.5$; with 90 per cent overshoot this jumps to 182 V. To obtain much advantage it is clearly necessary to minimize losses in the transformer and yoke cores, and this entails the use of more expensive material and the adoption of closer production tolerances.

The use of circuits of this type

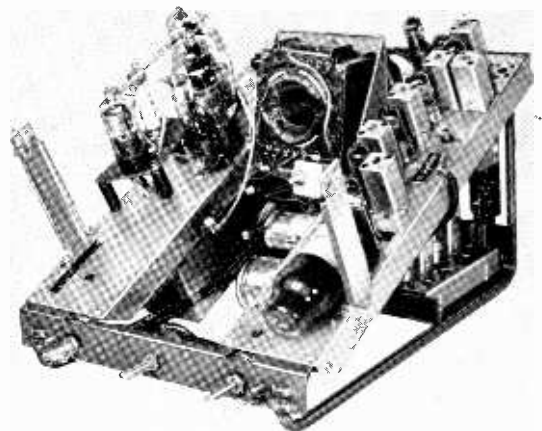

Chassis of the new Murphy television receiver. The line time-base has two valves in parallel as a self-oscillator.

is quite common when the number of lines exceeds 405. With the 405-line system, however, they are rarely used in receivers of what, until now, have been the standard type—sets using a mains transformer and an H.T. supply

Lines versus Cost—

of the order of 350 V. However, the technique of the A.C./D.C. broadcast receiver has recently been applied to television. The mains transformer has been eliminated with much saving of space and weight as well as cost. The result is an H.T. supply of about 190 V only, and the use of some form of economy circuit has become essential.

It is, perhaps, a little early to say definitely that this A.C./D.C. technique would be impracticable with more lines, but the indications are that it would hardly be feasible with any number greatly exceeding 405—at any rate, in the present state of the art.

It will be clear from this that the cost of a television receiver must inevitably increase with the number of scanning lines used in the system. It is difficult to give figures for the amount of the increase without designing and costing actual equipment, but it is easy to see that any substantial increase of lines will affect costs appreciably. One or two extra R.F. stages alone are hardly a negligible item; coupled with the alternatives of more H.T. power or more valves, a more complex circuit and closer manufacturing tolerances for the scanning components costs are likely to rise steeply. In addition, the savings just being made by the adoption of A.C./D.C. technique would hardly be possible.

Examples of television receivers available for the British viewer. They range in price from £64 to £77 (excluding Purchase Tax, which, on the Home market, is chargeable at the rate of 33½% of the wholesale price). The Bush TV2 receiver (right) and the Kolster Brandes CV40 set (below) both incorporate 12in. (30 cm) cathode-ray tubes. Of the 19 valves in the CV40 two—the R.F. amplifier and frequency changer—are common to both sound and vision.



The three receivers on this page cover the sound and vision wavebands only. The Cossor 912 (below) incorporates a 10in. (25 cm) tube giving a picture of 8.5 × 6.75in (22 × 17 cm). It has a cathode-follower vision amplifier.

LARGE SCREEN TELEVISION

Large-screen television for use in cinemas is being developed by Cinema-Television. The projector shown, which gives a screen picture 15ft × 12ft (4.6m × 3.7m), is controlled from a remote console. It is planned to equip two London cinemas experimentally.

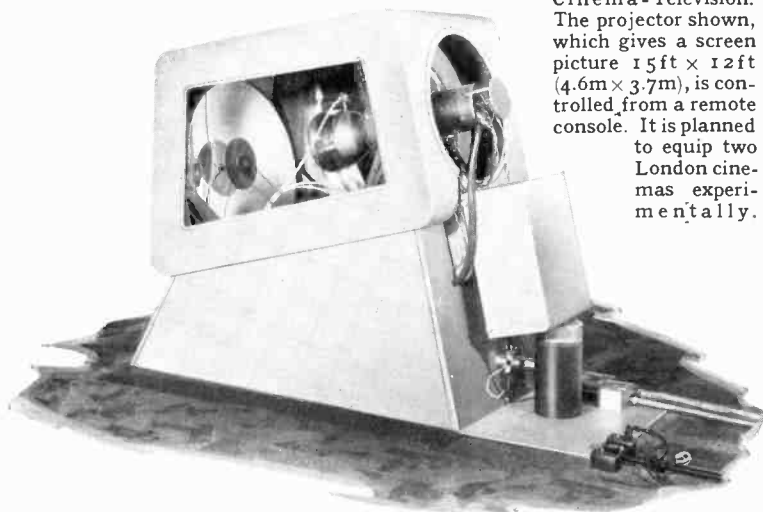

INTERNATIONAL TELEVISION

Problems of Distribution and Standardization

By THOMAS RODDAM

URING the past two years I have had the opportunity of talking to engineers from countries as far apart as Spain and Sweden. One of the things we have discussed has been television, not because I've been trying to sell anything, but because I'm curious to know how the non-technical side of the broadcasting administrations will solve the problem posed by the engineers. That problem is the problem of the television programme: now that we can transmit pictures, what pictures can we afford to transmit? In the United Kingdom this problem is not acute, because we have three densely populated areas: London, the Midlands and the Edinburgh-Glasgow region.

Nowhere else in Europe are so many potential viewers collected together conveniently into the service area of a television transmitter. There are, however, strong political reasons why the European countries must set up television stations: if the governments do not do something about it, the opposition parties are presented with a useful plank to their election platforms. It is therefore essential to find some way of solving the programme cost problem. There are other considerations, too. "What Manchester thinks to-day, London thinks to-morrow," and just as the Mancunian is convinced that a North-country television station should have preceded the London one, so in many countries at least two cities must be served if feelings are not to run high. This helps to provide the required number of viewers, but it adds to the capital cost of the system, as the amount of equipment involved is greatly increased.

The one thing which will really make European television a success, in my view, is a fully integrated programme service. The French would welcome a relay of the Glyndebourne Company's per-

formances at the Edinburgh Festival: the Londoner would like to see ski-jumping at St. Moritz. With an integrated programme service a potential audience of several millions becomes a possibility. Any programme of international interest, which means all the news broadcasts, with their separate language commentaries, ballet, opera, in fact, all the programmes which make their main appeal to the eye, can be shared, with an enormous broadening of the material available and an enormous saving of money. It is well within the financial capacity of any State to set up television transmitters and the interconnection circuits to its frontiers: it is not easy for most States to find the large production staff and the performers to

are to be imposed for these essential characteristics?"

This statement of the problem is followed by a questionnaire, containing 13 questions for study by the various administrations. I shall revert to these questions later, but it is first necessary to point out that, as things are at present, it is useless to study the problems of international circuits for transmitting television images, because there is nothing to be done with the signal when it arrives at the far end. Readers who do not know much about the work of C.C.I.F. may feel that it is not really important, because committees never reach any conclusions. Belloc's comment, "Only an aristocracy can be governed by committees," should make communication engineers look closely at their blood when they cut themselves shaving, be-

TABLE OF EUROPEAN STANDARDS

Country	Total number of lines, including those sacrificed for synchronizing	Images per second	Aspect ratio	Maximum frequency (Mc/s)
Great Britain ...	405	25	4/3	2.735
Germany	441	25	6/5	2.920
France	455	25	6/4	3.880
Netherlands ...	567	25	6/5	4.820

provide even 20 hours of programme a week. By linking the countries together, the saving is greater than can be estimated without a close examination of programme material. The studio broadcasts, which cost so much, are largely replaced by the international programme, either from the local opera house or from another country.

The technical side of the international television system is already receiving consideration. In 1945 the C.C.I.F.¹ put the following question² to one of its Committees of Reporters: "What are the essential characteristics of international circuits for the transmission of animate images (television) and what conditions

cause if Belloc was right, we are the only European aristocrats. C.C.I.F. does deliver the goods, and the successful operation of the European telephone network is a tribute to the hard work which is done by the members of the various committees. It is quite certain that the international standards will be agreed. In parallel, something must be done about radiating the signals.

A European standard is essential; what is available? The various existing standards and the characteristics of a system (the Dutch), which has been used experimentally, are³ shown in the table on this page.

Of these we may eliminate the German system, as presumably no

International Television—

one would wish to adopt this, based as it was on an industry which is now in ruins. Let us therefore confine our attention to the others. The French system has developed out of the pre-war one and has benefited from the experience gained during the war when the Eiffel Tower station was in operation with partly German equipment. Compared with the British system it provides a 12% increase in the number of lines, at the cost of an increase of 40% in bandwidth. The Dutch system is presumably not so thoroughly tested under service conditions, but I do not know whether it was in being before 1939. For a 40% increase in the number of lines, the bandwidth is increased by 75%.

There is no doubt that 400 lines, or 550, is not enough: what is wanted is 1,000 lines, with full colour! The objection is that with any known or foreseeable technique, the receivers for such high-grade systems will be far too expensive for most people. The real question to be decided is at what stage the marginal cost of the receiver outweighs the mar-

ginal improvement in definition. On this question I shall say nothing, because it must involve a long series of subjective tests. People tell me they consider 405 lines enough: certainly the tubes to give smaller spots cost enough money, and I tremble to think how much I should have to pay for a receiver with a response flat, without phase distortion, up to 5 Mc/s. I suggest that our wartime studies of pulse receivers may lead to rather better pictures than we expected for a given number of lines before the war.

Distribution over R.F. Cables

The aspect of the international standard which I want to discuss is that dictated by developments in telephony. High-velocity cables now being constructed in Europe¹ will eventually link all the capitals of Western Europe. On the present plan these co-axial systems fall into two main classes, those which operate up to 2.54 Mc/s and 2.788 Mc/s, and those which operate up to 4.028 Mc/s. These cables must form the backbone of any international television system. When I am in the office I want to use the telephone, and to use a 4-kc/s channel on a cable. When I go home I want a television programme, but I do not use the long-distance telephone. By allowing the cable to be diverted to television relaying when the tele-

phone traffic can be passed over other channels, fuller use is made of the facilities available, so that the cost is spread out. This use of circuits already either in existence or under construction will lead to a rapid development, and should ultimately benefit both telephone users and television viewers.

If this use of existing facilities is adopted, it must have a considerable effect on the choice of the standards for television broadcasting. There is little hope of being able to pipe 4.82 Mc/s about Europe for a very long time. The French cables, Paris-Lyon-Cannes, Paris-Basle, will pass up to 2.788 Mc/s, which will just deal nicely with the 405-line system, but will not serve to transmit the signals of the French 445-line television system. The authorities themselves will, no doubt, study this question more closely. It does appear, however, that the cable circuits will be particularly suitable for transmitting the 405-line television signals, and that some of the cables will also be able to handle more than 200 telephone channels at the same time. There are no serious technical problems involved in transmitting television signals over these cables. It is true that the equalizers must be designed more carefully, but this is simply the refinement of an existing technique. The amplifiers are already there, for they are needed for use with the cable.

This survey of the possibilities of international television is prompted by only one consideration. I do not like waste. To mess about with a different system in every country means that the work of engineers in developing television will be largely wasted, because it will be both expensive and parochial. An international programme pool can provide a much better service at a lower cost: engineering is the job of doing just that.

REFERENCES

¹ International Telephone Consultative Committee.

² Minutes of Meetings, XIIIth Plenary Assembly, C.C.I.F., London, 29th-30th October 1945, p. 109.

³ See Ref. 2, p. 111.

⁴ Programme Generale d'Interconnexion Telephonique en Europe (1947-1952), C.C.I.F., XIVth Assemblée Plénière, Montreux 1946 p. 60.

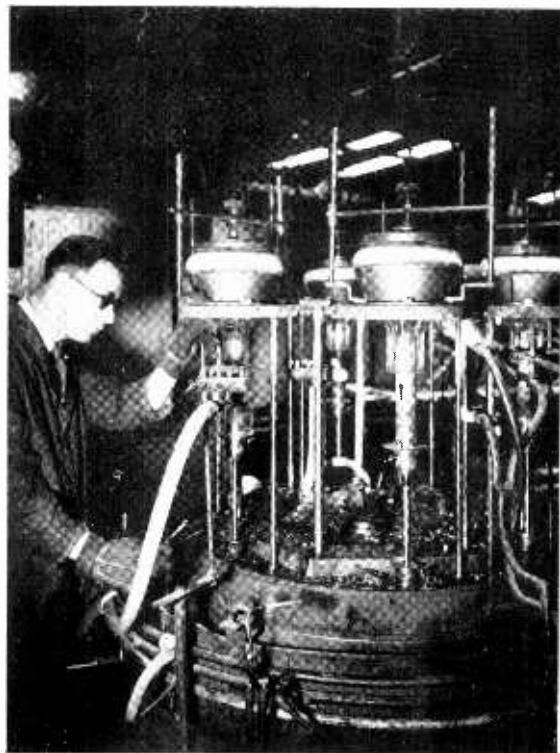

Difficulties in the production of C.R. tubes have in the past restricted the manufacture of sets. They are now mass produced as this picture of drop sealing of tubes on a rotary pump at the Edison Swan works shows

TELEVISION RECEIVER DESIGN

Present Trends of British Practice

By J. RHYS-JONES, M.I.E.E. (The Plessey Company)

SINCE the inception of the B.B.C. 405-line television transmissions late in 1936 British television has made steady progress and many tens of thousands of receivers are now in regular use. They have provided the industry with a large amount of experience of inestimable value to the designer and the production engineer.

No amount of purely laboratory work can provide the same information about the performance, reliability and user requirements as direct experience with large numbers of sets in the hands of the non-technical public. Through years of such experience the British television industry has learned what to do and what not to do in television receiver design. It has learned what electrical performance is required of the circuits and what electrical and mechanical properties the components must possess. It has also learned much about the requirements of picture presentation and the arrangement of the controls.

This last is an exceedingly important matter in satisfying the customer. It includes such matters as the achievement of sufficient circuit stability to avoid any need for adjusting controls over lengthy periods, the best distribution of the controls to suit the inexperienced user, and the choice of the range of the controls to cover the ageing of valves and components. In addition, the general appearance of the receiver, the avoidance of polished surfaces where they may reflect extraneous light to the viewers, and the nature of the immediate surround of the tube are all important factors contributing to the satisfaction of the user. It has been found, too, that the academic response curve does not in practice prove the most satisfactory. A more pleasing picture is obtained with a curve peaking between 2.5 and 3 Mc/s.

Until quite recently the usual practice in a television receiver has been to use a 9-in (23cm) C.R. tube with electromagnetic deflection and focusing and an E.H.T. supply of 4-6 kV derived from the 50-c/s mains through a half-wave rectifier and mains transformer. The saw-tooth oscillators were often blocking oscillators, but the use of thyratrons was quite common, and they fed pentode power amplifiers which supplied the saw-tooth current to the deflector coils. The receiver proper, if of the straight T.R.F. type, usually had 4 R.F. stages, a diode detector and one video stage. Two sound-channel rejector traps were included, and one or two of the R.F. stages were common to both sound and vision channels, the sound signal being

changer and two or three I.F. stages.

Quite recently noise limiters in both vision and sound channels have been rather widely introduced and have greatly improved the performance in noisy locations. In all sets the H.T. supply of the order of 300V has been derived from the mains through a transformer and full-wave rectifier.

Latest Equipment

These sets, typical of a year ago, were entirely satisfactory in performance, but the increasing costs of production were gradually lifting their prices out of the reach of the bulk of the public. Recent design has, therefore, tended not so much towards improving performance as to obtaining the same results more cheaply. No standardization of method has yet been achieved, and it is instructive to review some of the circuit features of the latest designs.

Little or no change has been

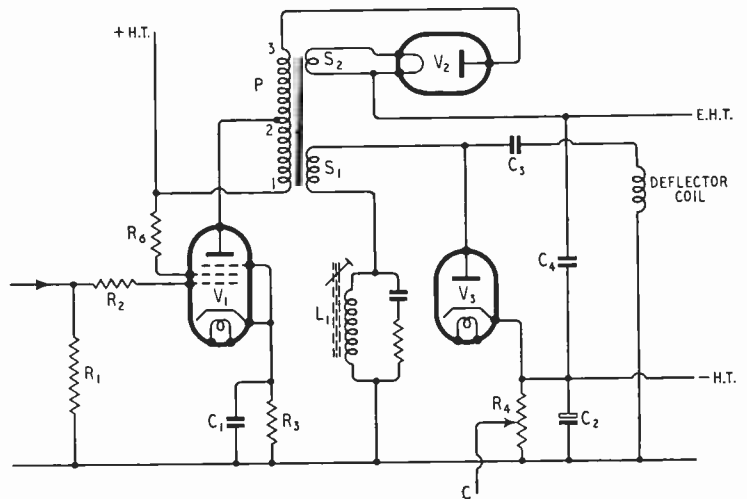

Fig. 1. Circuit of the Pye line-frequency time-base and E.H.T. supply.

picked out after this common amplification and applied to one or two R.F. stages followed by a detector and A.F. stage. Sometimes a superheterodyne was used and then one R.F. stage was usual followed by a frequency-

made in the receiver proper; the economies are mainly confined to the time-base and power supply circuits. Two features are becoming more or less general—developing the E.H.T. supply from the line fly-back and the adoption of

Television Receiver Design—

A.C./D.C. technique. These are well illustrated by the Pye B18T, which is a table-model receiver weighing only 30lb (13.7kg) and 44cm wide by 31cm high by 32cm deep. All valve heaters and the C.R. tube heater are connected in series, and the H.T. supply comes from the mains through a half-wave rectifier. No transformer is used but for supplies of less than 230V an auto-transformer is needed.

Time-Base Circuits

The line-scan circuit used in this set is particularly interesting and is shown in Fig. 1. The grid of the pentode V_1 is fed with a saw-tooth voltage generated by a blocking oscillator (not shown). The main primary winding P of the coupling transformer is the part 1, 2, and is connected in the anode circuit of V_1 . The secondary S_1 feeds the deflector coils through C_3 and the picture-width control L_1 . An 'efficiency diode' V_3 is connected effectively across the secondary; it is cut-off on fly-back and conducts on the scan. The current drawn through it on the scan flows into C_2 and the voltage developed across it is used to provide additional H.T. for V_1 and for the first anode of the C.R. tube.

The peak voltage on the anode of V_1 on fly-back is stepped up by the auto-transformer action of the transformer between 1, 2, and 1, 3, and applied to the rectifier V_3 , which has its filament heated by

saw-tooth current from S_2 . About 7kV is obtained, and the reservoir capacitance C_4 is actually the capacitance between the internal graphite coating of the C.R. tube, which is its final anode, and an external conducting coating.

Another example of simplification is presented in the new Murphy time-base circuit, the line-scan portion of which is shown in Fig. 2. Although a parallel-connected pair of valves is actually used in the receiver, this is basically a single-valve circuit, the tetrode valve being used as a self-oscillator. The anode transformer has a primary winding W_1 , coupled to two secondary windings W_2 and W_3 , the former of which supplies the line-deflec-

transformer. Starting from the instant of switching on the receiver, the principle of operation can best be described in a number of stages:—

1. Heater reaches emitting temperature.
2. Current commences to flow in the anode circuit. This current is initially microscopic in quantity, owing to the fact that there is no voltage applied to the screen.
3. The direction of connection of winding W_3 relative to winding W_1 on the anode transformer is such that an increase in anode current through winding W_1 results in the application of a positive potential to the screen. This

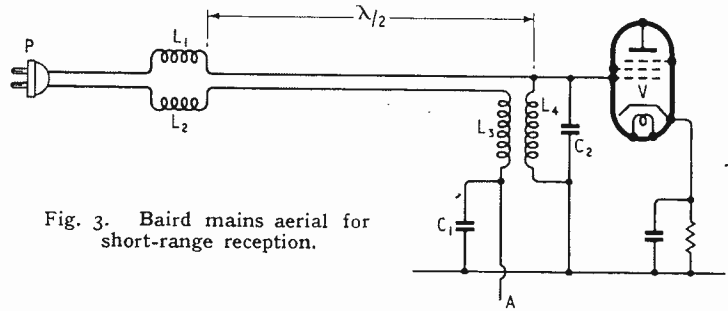

Fig. 3. Baird mains aerial for short-range reception.

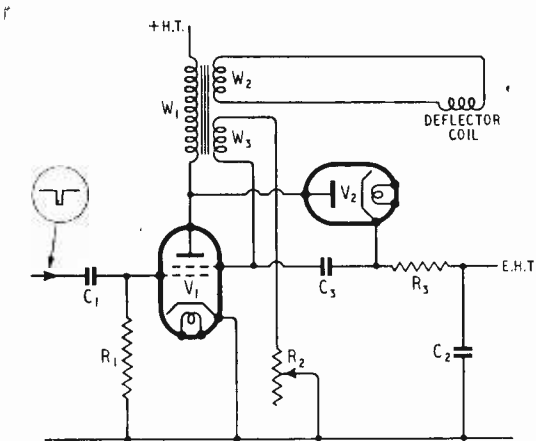

Fig. 2. Murphy line time-base; two valves in parallel are used for the self-oscillator V_1 .

tion coils in the usual way, and the latter of which is connected between the screen of the tetrode valve and ground, via the series variable resistance R_3 (line hold). Negative synchronizing pulses are

supplied to the grid through the differentiating circuit C_1R_1 . It will be noted that there is no normal high-tension supply to the tetrode screen, the screen power being obtained from the anode

results in a still greater anode current.

4. This chain action continues through the drive portion of the cycle, the anode current and screen voltage rising together.

5. During the scan the anode voltage is falling and the screen voltage rising. When the anode voltage falls below the screen voltage the two electrodes cease to be interdependent, and the rate of increase of the anode current starts falling off.

6. This action is again cumulative and continues rapidly until the anode current ceases to rise. The screen voltage then drops to zero.

7. The anode current now starts to fall, which applies a negative voltage to the screen, thus causing an extremely rapid cut-off of the anode current.

8. This sudden collapse of current in the winding W_1 produces a very high voltage at the anode, this voltage being dependent on the rate of change of the current,

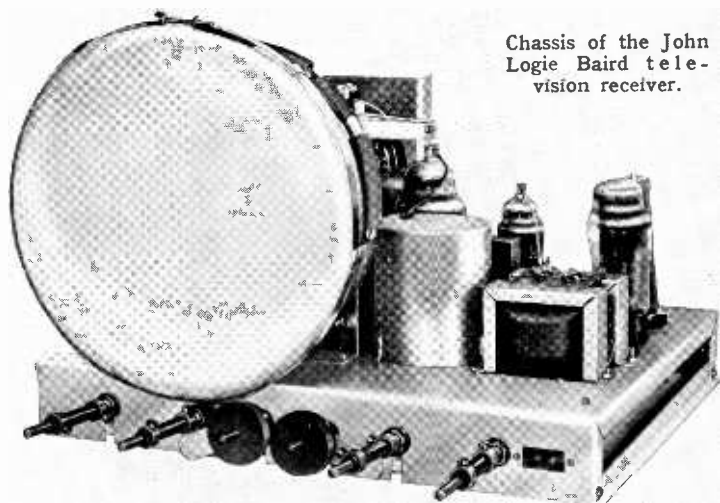

Chassis of the John Logie Baird television receiver.

interference peak of greater amplitude comes along the diode conducts and clamps the grid at but little more than the peak-white level. In this instance, the bias is adjustable by the potentiometer R. This control is adjusted until with no interference the diode is only just without effect on the picture. In view of its simplicity the circuit is remarkably effective in suppressing ignition interference. Circuits differing somewhat in details but of basically the same form are fitted to most present-day receivers.

Typical Specification

Having touched very briefly on a very few samples of new circuit trends, it might be of interest to endeavour to draw up a composite specification for a television receiver which may represent modern design technique.

Valves: Numbers between 13 and 19 total. Heaters series connected. Heater supply may be direct from the mains, or an auto-transformer may be used to obtain a higher voltage for H.T. and be tapped to supply the heaters.

Cathode-Ray Tube: 9-in face, all magnetic, giving a picture size approx. $7\frac{1}{2} \times 6$ in (19cm \times 15cm).

and the value of the inductance in which it is changing. In addition, a very high negative voltage appears at the screen.

9. This high positive potential which appears at the anode during the flyback portion of the cycle, is added to the high negative potential which appears at the screen, and after rectification and filtering provides some 6kV for E.H.T.

This set is of the A.C./D.C. type in that the valve heaters are connected in series, but an auto-transformer is used for all mains voltages.

Mains Aerial

Single-valve time bases are also used in the new Baird set, but of a somewhat different type. E.H.T. is taken from the line flyback once again, but this time a voltage-doubler circuit is used with metal rectifiers. Perhaps the most interesting, certainly the most novel, feature of this set is the mains aerial. It is, of course, intended only for use in areas of high field strength and provision is made for using a normal aerial when required. This part of the circuit is shown in Fig. 3, from which it will be seen that the two mains leads each have a series choke L_1 , L_2 fitted half a wavelength from the receiver. At the receiver end of the mains cord, one of the two wires in the mains lead is connected to the grid end of the tuned winding L_1 of the aerial coil, the other end

of this coil being connected directly to the receiver chassis (as is the practice with normal A.C./D.C. receivers). The other mains lead also connects to a coil L_2 , similar to the one just mentioned and coupled to it, and the bottom end of this coil, while it is by-passed to chassis with a capacitor C_1 , is actually connected to the hot end of the filament chain—a further example of standard A.C./D.C. practice.

The chokes L_1 , L_2 form a barrier to isolate the $\lambda/2$ section of the mains lead, and so it is virtually this section of the lead which forms the aerial.

As already stated, most sets have for some time included noise limiters in both sound and vision channels. In the vision channel a noise limiter is almost essential to prevent defocusing of the scanning spot on peaks of interference. With positive modulation ignition interference is most troublesome because noise peaks carry the tube beyond peak white and the resulting defocusing causes a white patch of quite large diameter. With a suitable limiter this defocusing is prevented and the interference is limited to a white pin point which is not very noticeable.

One form of the limiter is shown in Fig. 4. A diode is connected between the grid and cathode of the C.R. tube and biased so that it is just non-conducting when a peak-white signal is applied to the tube. When an

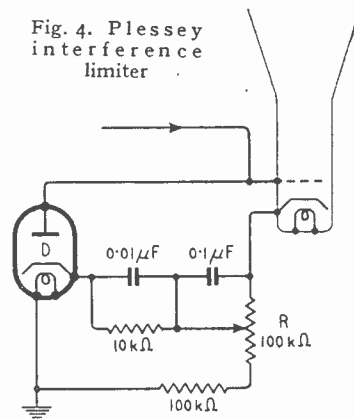

Fig. 4. Plessey interference limiter

Extra High-Tension: for supply of volts to the tube anode. The old 50-c/s supply is out and line flyback systems are most used. A voltage of 6-7 kV is used.

Amplification: While T.R.F. circuits appear to be gaining favour, superheterodyne circuits still have supporters. Sensitivities

Television Receiver Design—

have increased to better than $100\mu\text{V}$ input, although certain makers add an extra amplifier if high sensitivity is needed.

Power Consumption: Less than 150 watts.

Selectivity: The total number of tuned circuits in the video chain varies between 5 and 9; the total number of tuned circuits in the sound chain varies between 3 and 9. Up to six circuits may be common to sound and vision. Traps to remove sound from vision or vice versa are used, but do not usually exceed two in number.

Ringings: Earlier on it was remarked that a flat response over a wide bandwidth does not necessarily give the most satisfactory picture, and in addition it is prone to encourage interference. Many receivers incorporate filters in the video stage, which are resonant within the video pass-band, say, between 2.5 and 3 Mc/s, and are then suitably damped by a shunt resistance to have the desired value of Q factor. The tuned circuits are then adjusted to give a rise at the resonant frequency



Chassis undergoing production tests in a specially constructed booth at the Plessey works.

of the filter, followed by a rapid but smooth fall away above this frequency. This procedure results in an apparent depth of picture which makes for pleasant viewing.

Time Base and Scanning: In the interests of valve economy,

single-valve time-base circuits are coming into favour.

Cabinet: This receiver will either fit into a compact table model cabinet, or into a console viewing model. The compact nature of the "works" will ensure that the weight and size of the complete model will be reasonable.

In the foregoing, no mention has been made of the large luxury models, of the projection television developments, nor has any remark been passed about any combined models incorporating in the television cabinet such extras as radio, gramophone, cocktail bar, etc. This neglect was deliberate, for the television development of to-day can be summed up with the watchword 'simplicity.'



Combined television - radio-gramophone produced by Dynatron. Twenty-one valves are employed in the television chassis and twelve in the all-wave radio circuit. This set, which is 55-in (140 cm) wide and has a 12-in C.R.T., costs £325, plus Purchase Tax.

INDUSTRIAL CO-ORDINATION

THE war and increased governmental control have probably had at least one good result—they have led to closer consultation and co-ordination between the various branches of the British radio industry, increased pooling of technical knowledge and research, and closer contacts between the best scientific brains in the firms comprising the industry.

It is only since the war that the British radio industry has had one organization to co-ordinate its activities and to enable it to speak with one voice in its dealings with the Government, the B.B.C. and other bodies. This organization is the Radio Industry Council (R.I.C.) whose four constituent bodies represent respectively the receiving set makers, the makers of communication equipment and navigational aids, the component and test gear manufacturers and the valve manufacturers. Each body has its own council; each sends representatives to the R.I.C. and to the various committees of the Council. Each has



Dr. N. H. Searby, of Ferranti's search dept., who is chairman of the R.I.C. Technical Committee.

its own technical and other committees and sends representatives to many joint committees which may include representatives of other "legs" of the R.I.C. or other bodies, such as the B.B.C., General Post Office, British Standards Institution, Institution of Electrical Engineers, and so on.

How British Manufacturers Tackle Television Problems

By ANDREW REID

The R.I.C. has a Technical Directive Board, Technical Executive Committee and Television Policy Committee, but television from the point of view of receiver manufacture is in the first place the responsibility of the British Radio Equipment Manufacturers' Association, and it is in its committees that much detailed work is done. The B.R.E.M.A. Technical Committee, which meets monthly to direct technical policy for the handling of all problems relating to the design, development and manufacture of domestic radio and television receivers, consists of the senior technicians of each of the 12 firms represented on the Council of the Association. The Television Technical Sub-Committee, which sits regularly, is appointed by the main committee and consists of the senior television engineers of each of the same firms under the chairmanship of one of the members of the main Technical Committee. This sub-committee has a large number of items constantly before it, and to deal with them effectively appoints panels of two or three members who meet as required. Some of the subjects are referred to it from above; many others are raised by its own members and representations passed up to the main Committee.

Aims of the highly complex system of technical committees are to maintain a high standard of quality, design and workmanship, to give advice on manufacturing problems, to promote research in the interests of the industry, and to promote desirable standardization of equipment. Individual manufacturers are free to introduce new circuits and other improvements without pooling their ideas and designs, but technical data coming to the knowledge of the Association from outside the

industry is made available to all and leads to a steady and fairly uniform progression in design and manufacture.

Often a problem before the technical sub-committee will require research before recommendations can be made, and in this event a few members will collaborate in carrying out experimental work in their companies' laboratories.

Periodical meetings between members of the Technical Committee, sub-committee and B.B.C. television engineers take place, and problems of mutual interest are discussed informally. A number of improvements in the television service have been made as a direct result of this liaison, and the industry has been able to design receivers to give the full benefit of these improvements.

One of the problems continually before the sub-committee is the abatement of interference with television reception. On this the sub-committee has direct liaison with the G.P.O. and the Association is directly repre-

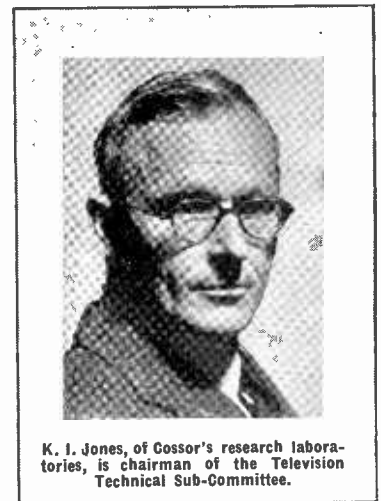

K. I. Jones, of Cossor's research laboratories, is chairman of the Television Technical Sub-Committee.

sented on various technical committees of the B.S.I. and the I.E.E.

A specification for the performance of television aerials, which will later have to be referred to the Radio Component Manufacturers' Federation, the standardization of plugs and sockets for

Industrial Co-ordination—

television input, and the synchronization of main supply frequencies are among other subjects of current investigation and discussion.

It was the Television Policy Committee of the R.I.C. which suggested that the question of international television standards in Europe should be raised at the C.C.I.R. conference at Stockholm last July, and a special Standards Advisory Committee was formed. The G.P.O., which provided the official British delegation to the conference, was accordingly accompanied by three advisers nominated by the industry from various technical committees, and international standards are now to be one of the subjects before a study group of the C.C.I.R.

Enough will have been said, perhaps, to indicate that the British television experts are looking ahead all the time, and that the R.I.C. organization, including its various constituent bodies, committees and sub-committees, is the repository of an amount of technical knowledge and experience of television which is probably unequalled in the world, and which is at the disposal of all countries contemplating the establishment of a television service.

Mullard's MTS240 receiver (right) incorporates an eight-valve superhet covering, in addition to television sound, the short, medium and long broadcast wavebands.

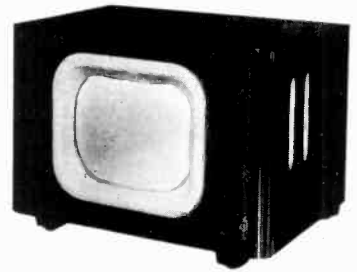

The first A.C./D.C. receiver, the Pye B18T, has been reduced in weight and bulk by dispensing with a mains transformer.

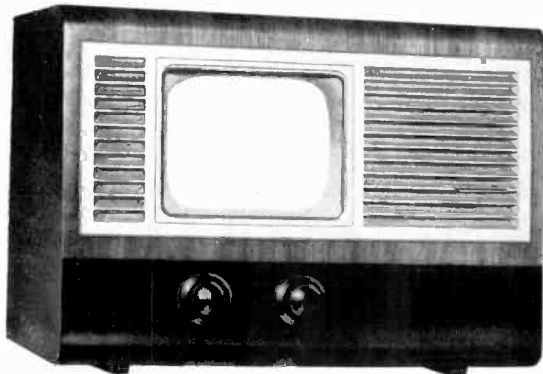
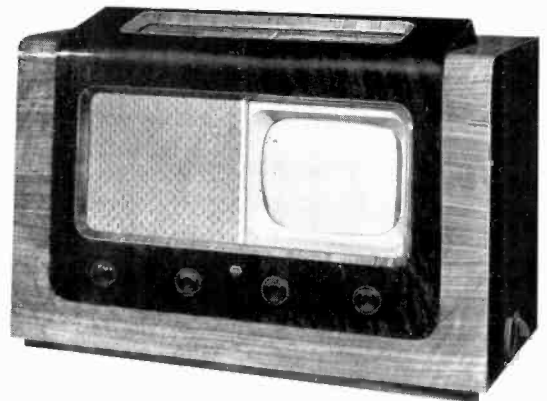

A flat-ended 9in. (23 cm) tube is used in the Ferranti T1146 receiver, which incorporates interference suppression circuits on both sound and vision.



The Ultra V470 19-valve receiver (left) is assembled in three units for ease of servicing.

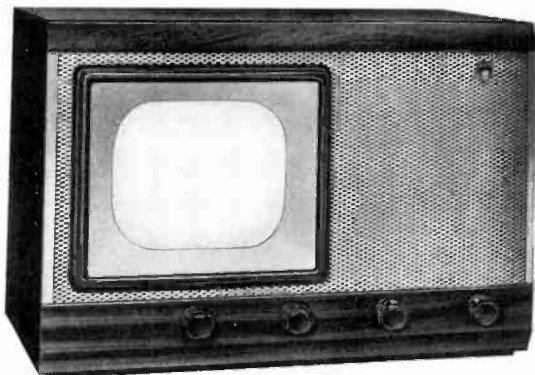

Ekcovision receiver TS46 made by E. K. Cole.

Vidor's 18-valve table model receiver, CN369A (below), gives a 7.5 x 6in. (19 x 15 cm) picture on its 9in., tube.

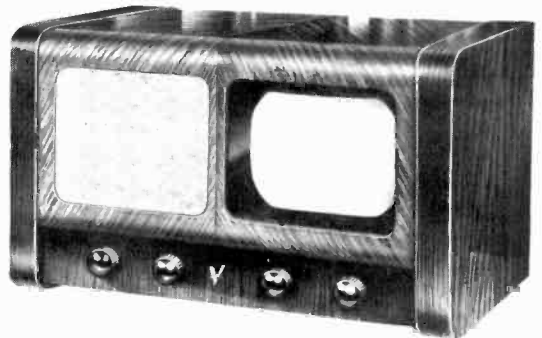

GENERAL INDEX

To facilitate reference the month of issue as well as the page number is given.

The General Index is followed by a Classified Index under the headings of Aerials, Design, Electronics, Manufacturers' Products, Miscellaneous, Modulation, Organization, Propagation, Radar, Sound Reproduction, Television, Test and Measurement, Transmission, Valves and Thermionics, Books, Illustrations and Authors. References to Authors, Books and Illustrations appear only in the Classified Index.

- A.C.** Bridges, by "Cathode Ray," 139, Apr.
A.S.E. now Admiralty Signal and Radar Establishment (*News*), 55, Feb.
A.W.F. Loudspeaker Cone Assemblies, 276, Aug.
Ace Radio Model 600, 307, Aug.
Aerial Corona Interference, by F. R. W. Strafford, 441, Dec.
Air Communications—S.B.A.C. Display, 366, Oct.
Aircraft and Television Interference (*Correspondence*), 306, Aug.; 386, Oct.; 425, Nov.
Air-Line Radio, 28, Jan.
Albert Mfg. Co. Condenser Scale and Drive, 282, Aug.
Albion Coll Packs, 99, Mar.
Allander Industries A-901 Battery Receiver, 195, May
Amateur Clubs & Societies. Lists, 109, Mar.; 230, June
 — **Examination Results** (*News*), 370, Oct.
 — **Frequencies** (*News*), 335, Sept.; 370, Oct.
 — **Operators' Qualifications** (*Correspondence*), 34, Jan.
 — **Radio Equipment—R.S.G.B. Show**, 14, Jan.
Ambassador 4756 Radiogramophone, 462, Dec.
Amplifier, Cascode: Electronic Circuitry, 249, July
 — **Design, High Quality**, by P. J. Baxandall, 2, Jan.; (*Correction*), 71, Feb.
 — **Direct-Coupled** (*Correspondence*), 266, July; 345, Sept.; 386, Oct.; 425, Nov.; 465, Dec.
 — **Economical 50-Watt**, by G. R. Woodville, 457, Dec.
 — **Quiet High-Gain**, by C. C. Whitehead, 208, June, (*Correction*), 384, Oct.
Amplifiers—Are High-powered Ones Necessary? by H. S. Casey, 299, Aug.; (*Correspondence*), 346, Sept.; 466, Dec.
 — **with Negative Feedback** (*Correspondence*), 233, June; 347, Sept.
Amplifying Crystal, 358, Oct.
Antiferre Television Aerials, 384, Oct.
Appleton, Sir Edward—Nobel Prize Winner (*News*), 22, Jan.
Artificial Acoustic Reflectors (*Correspondence*), 111, Mar.; 265, July
Atlantic City Conference (*Editorial*), 79, Mar.; Summary of the Findings, 148, Apr.
Atomic Energy, Electronics and, by E. W. Titterton, 40, Feb.
 — **Research**, 323, Sept.
Australian Television (*News*), 371, Oct.
- B.B.C.** Annual Reports (*News*), 143, Apr.; 369, Oct.
 — **Board of Management** (*News*), 21, Jan.
 — **F.M. and A.M. Controversy** (*Editorial*), 199, June; 239, July
 — **405 Lines to Stay**, (*Editorial*), 351, Oct.; (*News*), 369, Oct.
 — **Midland Television Frequencies** (*News*), 411, Nov.
 — **New O.B. Television Gear**, 320, Sept.
 — **Norwich Station Site** (*News*), 335, Sept.
 — **Scientific Advisory Committee**, 259, July
 — **Services** (*Correspondence*), 33, Jan.
 — **Silver Jubilee** (*News*), 101, Mar.
 — **Takes over Singapore Station** (*News*), 335, Sept.
 — **Television Standards** (*Editorial*), 351, Oct.; (*News*), 369, Oct.; (*Article*), 381, Oct.
- B.B.E.M.A.** Annual Report (*News*), 53, Feb.
Brit. I.R.E. Officers (*News*), 452, Dec.
B.S.R.A. Conference and Exhibition, 267, July
- B.S.R.A.** Discussion on Good Reproduction, 20, Jan.
 — **Discussion on Monitoring Loudspeakers**, 186, May
B.T.H. Crystal Valve, 155, Apr.
Batteries, New Vidor "Kalium" Cell, by R. W. Hallows, 352, Oct.; (*Correspondence*), 467, Dec.
Battery Developments, Dry, by R. W. Hallows and D. W. Thomasson, 166, May
Battery-Set Indicators (*Correspondence*), 266, July
Beam Switches: Electronic Circuitry, 403, Nov.; 444, Dec.
Better Listening (*Correspondence*), 426, Nov.
Brierley Ribbon Pick-up, 309, Aug.
British Components in Sweden, R.C.M.F., 143, Dec.
 — **Mechanical Productions P.T.F.E. Insulator**, 405, Nov.
 — **Sub-miniature Valves**, 80, Mar.; (*Correspondence*), 193, May
Broadcast Aerial Standardization (*News*), 189, May
 — **Receivers, Price of** (*Editorial*), 271, Aug.
Broadcasting, Extra-High-Frequency (*Editorials*), 199, June; 239, July; (*Correspondence*), 266, July; 305, Aug.; 425, Nov.
 — **Station, What Is a?** (*Editorial*), 1, Jan.
Burgoyne Aerial Connector, 61, Feb.
 — **Electric Soldering Gun**, 247, July
Bush Model EBS4: Test Report, 214, June
Business Radio (*Editorial*), 159, May
 — **Frequencies** (*News*), 180, May; 224, June
 — **Licences** (*News*), 143, Apr.; 336, Sept.
 — **Reporting—Press Pictures by Portable Equipment** (*News*), 260, July
- C.P.S.** Emitron Television Camera, 60, Feb.
Cable & Wireless Phototelegraphy Equipment (*News*), 21, Jan.
Car Radio, Radionobile 100: Test Report, 48, Feb.
Cascode Amplifier: Electronic Circuitry, 249, July
Cathode-Coupled Multivibrator: Electronic Circuitry, 249, July
 — **— Limiter: Electronic Circuitry**, 283, Aug.
 — **— Follower: Electronic Circuitry**, 321, Sept.
Cathode-Ray Oscilloscope, by S. A. Knight, 432, Dec.
 — **Tube Data**, by D. W. Thomasson, 296, Aug.
Celco Carbon Resistors, 269, July
Cinema-Television Universal Oscilloscope, 99, Mar.
Circuit Symbols, by L. H. Bainbridge-Bell, 437, Dec.
Clandestine Radio, 13, Jan.; (*Correspondence*), 154, Apr.
Cleaning Switch Contacts, by J. J. Payne, 51, Feb.; (*Correspondence*), 194, May
Clive Courtenay Television Pre-Amplifier, 61, Feb.
Coil-Pack Modification, by L. Miller, 59, Feb.
Commercial Disc Recording I.E.E. Discussion, 67, Feb.
Components for Amateurs (*Correspondence*), 75, Feb.; 112, Mar.
 — **for Export—R.C.M.F. Exhibition** (*Editorial*), 119, Apr.
 — **Invisible, by "Cathode Ray"**, 459, Dec.
 — **"Constant Current" Circuit: Electronic Circuitry**, 404, Nov.
Copenhagen Conference—Europe's Frequencies (*Editorial*), 391, Nov.; (*List*), 397, Nov.
Cosmor 487 A.C. Console, 220, June
 — **912 Television Receiver**, 404, Nov.
- Crystal for Amplifying**, 358, Oct.
 — **Sets, New-Look**, by R. G. Hibberd, 210, June
- DECCA** "firr" Pickup, 364, Oct.
Deflector-Coil Efficiency, by W. T. Cocking (*Correction*), 35, Jan.
 — **Frame**, by W. T. Cocking, 289, Aug.
Degrees for Ex-Servicemen (*Correspondence*), 112, Mar.
Denco Coil Turret, 154, Apr.
Detection, High Level, by W. MacLanahan, 330, Sept.; (*Correspondence*), 194, May; 426, Nov.; 465, Dec.
Direct-coupled Amplification for Photocells: Electronic Circuitry, 445, Dec
 — **— Amplifier** (*Correspondence*), 266, July; 345, Sept.; 386, Oct.; 425, Nov.; 465, Dec.
Discriminators, Why Align? by Thomas Roddam, 240, July; by A. G. Crocker, 312, Sept.; (*Correspondence*), 386, Oct.; 425, Nov.
Distortion Again, by "Cathode Ray," 392, Nov.
Does Distortion Matter? — I.E.E. Discussion, 97, Mar.
Douglas Harbour Radar, 130, Apr.
Dry Battery Developments, by R. W. Hallows and D. W. Thomasson, 166, May
Dynamic Distortion Detector, by R. Danziger, 213, June
- E.H.F.** Broadcasting (*Editorials*), 199, June; 239, July; (*Correspondence*), 266, July; 305, Aug.; 425, Nov.
 — **in U.S.A.**, by Sarkes Tarzian, 297, Aug.
Economical 50-watt Amplifier, by G. R. Woodville, 457, Dec.
Eddystone 145-Mc's Tuning Unit, 405, Nov.
- EDITORIALS:**
Atlantic City Conference, 79, Mar.
B.B.C. Television, 351, Oct.
Broadcast Receivers, 271, Aug.
Business Radio, 159, May
Components for Export—R.C.M.F. Exhibition, 119, Apr.
Europe's New Broadcasting Frequencies, 391, Nov.
Extra-High-Frequency Broadcasting, 199, June; 239, July; (*Correspondence*), 266, July; 305, Aug.; 425, Nov.
Future of Radiolympia, 79, Mar.
Marine Applications of Radar, 311, Sept.
Nomenclature, 311, Sept.
Post Office Control, 1, Jan.
Radio Equipment of Buildings, 271, Aug.
Revolt against Superlatives, 239, July; (*Correspondence*), 346, Sept.
Short-Wave Broadcasting Under Fire, 39, Feb.
Wireless Telegraphy Bill, 431, Dec.
- Ekco A52 Table Superhet: Test Report**, 94, Mar.
CR61, Car Radio, 445, Dec.
U75 A.C./D.C. Superheterodyne, 307, Aug.
Consolette A.C./D.C. Portable, 462, Dec.
Princesa Portable, 195, May
Electro Methods Pre-set Resistors, 446, Dec.
Electromagnetic Units and Definitions, by Geoffrey Stedman, 406, Nov.
Electronic Circuitry, by J. McG. Sowerby, 249, July; 283, Aug.; 321, Sept.; 379, Oct.; 403, Nov.; 444, Dec.
 — **Megohmmeters**, by H. G. M. Spratt, 354, Oct.
Electronics and Atomic Energy, by E. W. Titterton, 40, Feb.
 — **and Space Flight**, 27, Jan.
 — **at Harwell**, 323, Sept.

Engineers' Guild (*News*), 145, Apr.
 Eta Pre-set Tuner Unit, 298, Aug.
 European Regional Broadcasting Conference (*News*), 223, June; 259, July
 Europe's New Broadcasting Frequencies (*Editorial*), 391, Nov.; *List*, 397, Nov.
 Everett Edgecumbe Electronic Kilo-volt-ampere Meter, 61, Feb.
 Ex-Service Cathode-ray Tubes, by D. W. Thomasson, 296, Aug.
 Exhibitions:
 B.S.R.A., 267, July; Copenhagen Television (*News*), 369, Oct.; Physical Society's, 174, May; R.C.M.F., 131, Apr.; R.C.M.F. in Sweden, 443, Dec.; Radiolympia (1949), 100, Mar.; S.B.A.C. Display, 366, Oct.
F.M. v A.M. (*Editorials*), 199, June; 239, July; (*Correspondence*), 266, July; 305, Aug.; 425, Nov.
 --- and Monopoly (*Correspondence*), 34, Jan.; 73, Feb.; 112, Mar.; 153, Apr.
 --- Band-width, Reducing, by A. G. Chambers, 221, June
 --- Reception, by D. Maurice and R. J. H. Slaughter, 103, Mar.; (*Correspondence*), 193, May
 --- Sets, Overcoming the Difficulties of Aligning, by Thomas Roddam, 240, July; by A. G. Crocker, 312, Sept.; (*Correspondence*), 386, Oct.; 425, Nov.
 --- Transmitter Receiver, 35, Jan.
 Flip-Flop Circuits: Electronic Circuitry, 379, Oct.
 Frame Deflector-coil Efficiency, by W. T. Cocking, 289, Aug.
 French Television (*News*), 53, Feb.
 --- High-Definition Television (*News*), 411, Nov.; 450, Dec.
 Frequencies, Europe's New Broadcasting (*Editorial*), 391, Nov.; (*List*), 397, Nov.
 Frequency Modulation, by "Cathode Ray," 339, Sept.
 --- Shift Keying, by Thomas Roddam, 400, Nov.
 --- Stabilization at E.H.F., 248, July
 --- Test Records, Decca, 211, June
 Fresh Progress in Dry Batteries, by R. W. Hallows, 352, Oct.; (*Correspondence*), 467, Dec.
 Full-wave Detection (*Correspondence*), 306, Aug.
G.E.C. BC4941 Portable, 220, June
 --- BC4956 Table Battery Set, 320, Sept.
 --- BT7094 Radio/Television Receiver, 320, Sept.
 G.P.O. and Wired Wireless (*News*), 260, July
 Gas Molecules as Resonators, 248, July
 Gee, Scottish Chain (*News*), 370, Oct.
 General-Purpose Oscilloscope, by J. F. O. Vaughan, 160, May
 Germanium Amplifying Crystal, 358, Oct.
 Goodmans' Axion 12 Loudspeaker, 155, Apr.
 Government Hearing Aid, 11, Jan.
 Gramplan 3512/15 P.M. Loudspeaker, 220, June
H.F.: Necessary and Nice? (*Correspondence*), 34, Jan.; 111, Mar.; 265, July
 Halliçrafter-Mullard Agreement (*News*), 295, Aug.
 Harbour Radar at Liverpool, by R. F. Hansford, 317, Sept.; (*Editorial*), 311, Sept.
 Hearing Aid, Government, 11, Jan.
 Heater Circuits, Series Capacitor, by A. W. Stanley, 332, Sept.; (*Correspondence*), 385, Oct.; 426, Nov.
 Heater Hum, Reducing, by K. G. Britton (with P. E. Baylis), 360, Oct.; *Correspondence*, 467, Dec.
 Hermes "Radio Tourist" Portable, 47, Feb.; (*Correction*), 99, Mar.
 Hifam: E.H.F. A.M. Broadcasting in U.S.A., by Sarkes Tarzian, 297, Aug.
 High-Level Detection, by W. MacLanachan, 330, Sept.; (*Correspondence*), 194, May; 426, Nov.; 465, Dec.
 High-Quality Amplifier Design, by P. J. Baxandall, 2, Jan.; (*Correction*), 71, Feb.
 --- Amplifiers (*Correspondence*), 33, Jan.
 --- Stability LC Oscillator, by Thomas Roddam, 286, Aug.
 Honours, New Year, 54, Feb.; Birthday, 260, July

I.E.E. Commercial Disc Recording, Discussion, 67, Feb.
 --- Council and Radio Section Committee, 295, Aug.
 --- Does Distortion Matter? Discussion, 97, Mar.
 --- "Scientific Radio" Convention, 100, Mar.
 Impregnated Windings (*Correspondence*), 74, Feb.
 Inapt Nomenclature (*Correspondence*), 111, Mar.
 India's New Stations (*News*), 182, May
 Industrial Electronic Apparatus, by D. W. Thomasson, 88, Mar.
 Institute of Recorded Sound Formed (*News*), 144, Apr.
 Interference, Aerial Corona, by F. R. W. Stafford, 437, Dec.
 International Television Conference, Zurich (*News*), 335, Sept.; 370, Oct.
 Investigating Anomalous Propagation (*News*), 181, May
 Invicta Radio Model 31 Superhet, 195, May
 --- 91G Radiogramophone, 462, Dec.
 --- 92 Superhet Battery Receiver, 384, Oct.
 --- 200 Superhet A.C./D.C., 266, July
 Invisible Components, by "Cathode Ray," 459, Dec.
 Ionosphere Review, 1947, by T. W. Bennington, 44, Feb.
 Is Discriminator Alignment So Difficult? by A. G. Crocker, 312, Sept.; (*Correspondence*), 386, Oct.; 425, Nov.
"J" What it is, and How to Use It, by "Cathode Ray," 68, Feb.
K.B. DR10, DR15 and DR20 Receivers, 462, Dec.
 Keying, Frequency Shift, by Thomas Roddam, 400, Nov.
 Kresta Car Radio, 285, Aug.
LC Oscillator, High-stability, by Thomas Roddam, 286, Aug.
 Labgear Pre-Amplifier Converter, 282, Aug.
LETTERS TO THE EDITOR:
 Against Super-regeneration, E. J. Williams, 265, July
 Aircraft and Television Reception, R. M. Staunton-Lambert, 306, Aug.; D. M. Gibson, E. E. S. E. Wall, 386, Oct.; G. C. Turner, M. A. Salter, 425, Nov.
 Amateur Operators' Qualifications, "Amrad," 34, Jan.
 Amplifiers with Negative Feedback, Howard Booth, 233, June; C. C. Gerry, 347, Sept.
 Assessing Distortion, K. Smith, 466, Dec.
 B.B.C. Services, Gordon Winter, 33, Jan.
 Better Listening, Raymond E. Cooke, 426, Nov.
 British Sub-miniature Valves, J. P. Aasenheim, 193, May
 Claudestine Radio Transmissions, C. D. Simmonds, 154, Apr.
 Cleaning Switch Contacts, G. L. Wallach; R. V. Goode, 194, May
 Components for Amateurs, S. Johnson, 75, Feb.; W. F. Taylor, 112, Mar.
 Degrees for Ex-Servicemen, O. S. Puckle, 112, Mar.
 Direct-coupled Amplifier, N. Bonavia-Hunt, 266, July, 425, Nov., 466, Dec.; E. Jeffery, 345, Sept.; P. J. Baxandall, 386, Oct.; F. Astin, A. Shackman, 465, Dec.
 Discriminator Alignment, E. F. Good, 386, Oct.; Thomas Roddam, 425, Nov.
 E.H.F. Broadcasting, Thomas Roddam, 266, July; D. W. Thomasson, 305, Aug.; E. C. Neate, 425, Nov.
F.M. and Monopoly, W. H. Cazaly, 34, Jan., 112, Mar.; T. H. Kinman, 73, Feb.; S. G. Barrrell, 74, Feb.; 153, Apr.
F.M. Reception, J. E. Pateman, 193, May
 Full-wave Detection, E. F. Good, 306, Aug.

H.F.: Necessary and Nice? R. Marker, 34, Jan.; Deamond Roe, 111, Mar.; P. J. Walker, 265, July
 High-level Detection, W. MacLanachan, 194, May, 465, Dec.; E. F. Good, 426, Nov.
 High-Quality Amplifiers, Trefor Williams, 33, Jan.
 Impregnated Windings, D. W. Thomasson, 74, Feb.
 Inapt Nomenclature M. G. Scroggie, 111, Mar.
 Indicators for Battery Sets, Dr A. Bell, 266, July
 Long-range Television, H. W. S. Long, 235, June; H. G. M. Spratt, 345, Sept.; R.A.S., 426, Nov.
 Magnetic Recording, L. G. Woollett, 112, Mar.; H. Bishop, 154, Apr.; E. B. Angold, 235, June.
 Meaningless Misnomers, H. Jefferson, 346, Sept.
 Mercury for Dry Cells, W. J. Tuffin, 467, Dec.
 "Micro-Waves and Waveguides," H. M. Barlow, 153, Apr.
 Onlaying, W. Ire Less, 305, Aug.
 Parasitic Oscillations, H. O. Humphreys, 265, July
 Planless Television, H. T. Stott, 305, Aug.
 "Principles of Radar," K. W. Pearson, 386, Oct.
 Quality in the Home, "Cathode Ray," 346, Sept.
 Radiated Interference, R. A. Collins, 113, Mar.
 Reducing Heater Hum, R. Townsend, 467, Dec.
 Resistor Ratings, A. E. Bennett, 466, Dec.
 Selectivity in Television Receivers, H. G. M. Spratt, 386, Oct.
 Series-capacitor Heater Circuits, G. S. Light, J. Parkinson, A. W. Stanley, 385, Oct.; S. V. Stephens, 426, Nov.
 Short-Wave Broadcasting, F. W. T. Atkin, 73, Feb.
 Superlatives, A. L. Vinycomb, 346, Sept.
 Surgeless Volume Expansion, A. A. Tomkins, 234, June; (*Correction*), 347, Sept.
 Symbol of Inconstancy, D. K. McCreery, 111, Mar.; L. Bainbridge Bell, 153, Apr., 346, Sept.
 Tax on Valves, Robert C. Bell, 347, Sept.
 Television and Thunderstorms, Otfred Reiger, 75, Feb.
 Television Standards, G. H. L. Thomas, 74, Feb.; Geoffrey Lees, 426, Nov.
 Tonal Balance, R. T. L. Allen, 113, Mar.
 Valve standardization, K. E. Marcus, 265, July
 Licences (*News*), 24, Jan.; 55, Feb.; 100, Mar.; 145, Apr.; 181, May; 225, June; 260, July; 294, Aug.; 336, Sept.; 370, Oct.; 412, Nov.; 451, Dec.
 Load—or Burden, by "Cathode Ray," 107, Mar.
 London-Birmingham Television Link (*News*), 143, Apr.
 Long-Range Television (*Correspondence*), 235, June; 345, Sept.; 426, Nov.; (*News*), 450, Dec.
 Loudspeakers, Single-Diaphragm, by A. Cecil Barker, 217, June
 Low-Power Transmission, by W. Oliver, 25, Jan.
M.R. Supplies Multi-Ratio Output Transformer, 247, July
 Magnetic Recording (*Correspondence*), 112, Mar.; 154, Apr.; 235, June
 Marconi on Radar, 1922 Forecast, 427, Nov.
 Marine Applications of Radar (*Editorial*), 311, Sept.
 Meaningless Misnomers (*Correspondence*), 346, Sept.
 Measurement Service, A.F., 195, May
 Megohmmeters, Electronic, by H. G. M. Spratt, 354, Oct.
 Meteor Electronics Midget Coils, 99, Mar.

Microwave Equipment, Plessey Multi-Channel System, 179, May
 "Micro-Waves and Waveguides" (Correspondence), 183, Apr.
 Midland Television Frequencies (News), 411, Nov.
 --- Map, 212, June
 Miers & Co., Sound Reinforcement System, 325, Sept.
 Millimetre Wavelengths, 258, July
 Miniature F.M. Transmitter-Receiver, 35, Jan.
 Modulation, etc., by "Cathode Ray," 253, July
 Monitoring Device for Broadcast Transmitters, by R. Danziger, 213, June
 --- Loudspeakers, 196, May
 Morse, News in (News), 54, Feb.
 Mullard-Hallcrafters Agreement (News), 295, Aug.
 --- New Valves, 446, Dec.
 Multi-Channel Communication System, G.E.C., 93, Mar.
 Multitone Hearing Aid, 357, Oct.
 Multivibrator, Cathode-Coupled, 249, July
 Murphy Radio A124 Baffle-Type Receiver, 320, Sept.
 --- 123 A.C. and Universal Receivers, 195, May
 N.P.L. Annual Exhibition (News), 293, Aug.
 Navigational Films (News), 23, Jan.
 Negative Feedback Amplifiers with (Correspondence), 333, June; 347, Sept.
 --- Calculations, by E. J. James, 326, Sept.
 --- Circuit: Electronic Circuitry, 233, Aug.
 --- Frequency, by "Cathode Ray," 361, Oct.
 New-look Crystal Sets, by R. G. Hibberd, 210, June
 Nomenclature (Editorials), 239, July; 311, Sept.; (Correspondence), 346, Sept.
 "Nucleonic" Equipment, Dynatron, 436, Dec.
OBITUARY: Brown, S. G., 336, Sept.; Burrows, Arthur, 23, Jan.; Butler, F. E., 181, May; Hunt, Cyril, H., 145, Apr.; Moody, Alex., 336, Sept.; Paterson, Sir Clifford, 336, Sept.; Powell, Sir Allan, 101, Mar.; Rybkin, Piotr Nikolayevich, 181, May; Swift, H. Bevan, 451, Dec.; Warner, K. B., 412, Nov.
 Oscillator, High-stability LC, by Thomas Boddam, 286, Aug.
 --- Single-valve A.F., by K. C. Johnson, 82, Mar.
 Oscilloscope, Cathode-Ray, by S. A. Knight, 432, Dec.
 --- General-Purpose, by J. F. O. Vaughan, 159, May
 Output Transformer Efficiency, by A. E. Falkus, 26, Jan.
PARASITIC Oscillations (Correspondence), 265, July
 Parmeko "Mercury" Transformers and Chokes, 446, Dec.
 "Personal" Radio Telephones, 409, Nov.
PERSONALITIES: Adams, A. E., 54, Feb.; Allen, C. G., 451, Dec.; Angwin, Sir Stanley, 336, Sept.; Appleton, Sir Edward, 22, Jan., 294, Aug.; Ashbridge, Sir Noel, 412, Nov.; Bedford, L. H., 294, Aug.; Bishop, H., 451, Dec.; Brown, Air Comdr. C. P., 54, Feb.; Capon, S. H., 23, Jan.; Clark, R. G., 54, Feb.; Cockcroft, Sir, J. D., 54, Feb.; Colpitts, Dr. E. H., 451, Dec.; Condliffe, G. E., 260, July; Coursey, P. R., 451, Dec.; Dalton-Morris, Air Comdr. L., 23, Jan.; Date, W. H., 34, Feb.; Davies, T. A., 144, Apr.; Dellinger, Dr. J. H., 260, July; Denham, H. S., 451, Dec.; Dippy, B. J., 260, July; Fairfield, C. L. G., 54, Feb.; Farren, L. I., 54, Feb.; Faulkner, H., 451, Dec.; Ferranti, Sir Vincent de, 54, Feb.; French Lt.-Col. W., 260, July; Goldup, T. E., 294, Aug.; Gracie, A. J. A., 144, Apr.; Guest, E. F., 181, May; Gwynn, S. B., 54, Feb.; Hayes, L. W., 370, Oct., 451, Dec.; Hayward, L. H., 260, July; Higgins, W. F., 260, July; Holman, J. V., 54, Feb.;

Hughes, J. R., 101, Mar.; Ingram, C. A., 23, Jan.; Kemp, R. J., 101, Mar.; Lewis, H. A., 412, Nov.; Lloyd, W. J., 412, Nov.; McCallister, E. S., 54, Feb.; McMichael, Leslie, 23, Jan., 412, Nov.; McVie, A., 54, Feb.; Miller, W. E., 336, Sept.; Northlife, C. R., 294, Aug.; Perkins, D. H., 260, July; Phillips, C. G., 54, Feb.; Pol. Prof. Balhu van der, 370, Oct., 412, Nov.; Puckle, O. S., 54, Feb.; Read, Col. A. H., 144, Apr.; Reed, Morris, 145, Apr.; Reid, Andrew, 54, Feb.; Richardson, Air Comdr. E. H., 23, Jan.; Ridgeway, J. W., 101, Mar.; Robb, J. G., 101, Mar.; Robinson, D., 55, Feb.; Ryde, J. W., 181, May; Smale, J. A., 101, Mar.; Smith, Frederick, 295, Aug.; Smith, G. Dariley, 101, Mar.; Smith-Rose, Dr. R. L., 53, Feb., 412, Nov.; Southwell, Sir R. Y., 54, Feb.; Stanley, C. O., 101, Mar.; Stephens, G. L., 260, July; Strutt, Dr. M. J., 145, Apr.; Sutherland, F. Neil, 101, Mar.; Tomlin, G. M., 260, July; Toone, F. J., 54, Feb.; Watterson, Maj. H. E., 370, Oct.; Willett, Capt. B. R., 101, Mar.; Williams, Dr. R. C. G., 101, Mar., 181, May; Wolfson, H., 54, Feb.
 Phase, by "Cathode Ray," 187, May; 227, June
 "Phasitron" Kinematograph Society Paper, 168, May
 Phillips A.C./D.C. Receiver, 99, Mar.
 --- 383A and 663A Television Receivers, 404, Nov.
 --- 474B Battery Superhet, 307, Aug.
 Photoceles, Direct-coupled Amplification of, 445, Dec.
 Physical Society Exhibition (News), 55, Feb.; Report, 174, May
 Plausless Television (Correspondence), 305, Aug.
 Plessey Coaxial Connectors, 404, Nov.
 Plessey-Bendix Agreement (News), 337, Sept.
 --- Edlswan Agreement (News), 371, Oct.
 Post Office Control (Editorial), 1, Jan.
 Power Supplies, Stabilized, by M. G. Scroggie, 373, Oct.; 415, Nov.; 453, Dec.
 Price Freezing of Receivers (News), 145, Apr.
 "Principles of Radar" (Correspondence), 386, Oct.
 Printed Circuits, Ward Blenkinsop, 220, June
 Progress in Components, R.C.M.F. Exhibition, 131, Apr.
 Purchase Tax on Batteries (News), 21, Jan.; on P.A. Gear (News), 225, June, 337, Sept.; Receivers (News), 180, May, 259, July; on Pickups, 294, Aug.; on Records, 336, Sept.; on Valves (News), 21, Jan., 259, July, (Correspondence), 347, Sept.; on Kits (News), 259, July, 369, Oct.
 Push-Pull Input Circuits, by W. T. Cocking
 1: General Principals, 7, Jan.
 2: Cathode-follower Phase-splitter, 62, Feb.
 3: Phase Reversers, 85, Mar.
 4: The Anode Follower, 126, Apr.
 5: Cathode-Coupled Stage, 183, May
 Pye M78F Miniature Battery Portable, 307, Aug.
QUALITY in the Home, by H. S. Casey, 299, Aug.; (Correspondence), 346, Sept.; 466, Dec.
 --- Receiver without A.F. Stage, by W. MacLanachan, 330, Sept.; (Correspondence), 426, Nov.; 465, Dec.
 Quartz Crystals, Marconi's, 207, June
 Quiet High-gain Amplifier, by C. C. Whitehead, 208, June; (Correction), 384, Oct.
R.C.M.F., Broadcast Aerial Standardization (News), 180, May
 --- Components Exhibition (News), 55, Feb.; (Editorial), 119, Apr.; Report, 131, Apr.; List of Exhibitors, 136, Apr.
 --- Council (News), 226, June
 --- Radio Interference Measures, 359, Oct.
 --- Stockholm Show, (News), 335, Sept., 443, Dec.

1948
 R.N.V.(W.) R. Reconstituted (News), 450, Dec.
 R.S.G.B. Exhibition, 14, Jan.
 --- Headquarters Station (News), 335, Sept.
 --- Membership (News), 55, Feb.
 R.T.E.B. Television Exam (News), 260, July.
 Radar: Watson Watt's First Patent (News), 53, Feb.
 Radlated Interference (Correspondence), 113, Mar.
 Radio Amateurs' Examination Results, 29, Jan.
 --- and Television Trade Federation Formed (News), 102, Mar.
 --- Developments in France, 418, Nov.
 --- Equipment of Buildings (Editorial), 271, Aug.
 --- Interference Measurement, 359, Oct.
 --- Service Trade Register (News), 100, Mar.
 Radiolympia, Future of (Editorial), 79, Mar.; (News), 100, Mar.
 Radiomobile 4020 Car Radio, 445, Dec.
 Rainbow Radio 843 Receiver, 462, Dec.
 RANDOM RADIATIONS, by "Diallist," 36, Jan.; 76, Feb.; 116, Mar.; 156, Apr.; 196, May; 236, June; 268, July; 308, Aug.; 348, Sept.; 388, Oct.; 428, Nov.; 468, Dec.
RECENT INVENTIONS, 38, Jan.; 78, Feb.; 118, Mar.; 158, Apr.; 198, May; 238, June; 270, July; 310, Aug.; 350, Sept.; 390, Oct.; 430, Nov.; 470, Dec.
 Record Library (News), 294, Aug.
 Reducing F.M. Bandwidth, by A. G. Chambers, 221, June
 --- Heater Hum, by K. G. Britton with P. E. Baylis, 360, Oct.; (Correspondence), 467, Dec.
 Resistor Ratings, by H. G. M. Spratt, 419, Nov.; (Correspondence), 466, Dec.
 Revolt Against Superlatives (Editorial), 239, July
 Richard Allen Radio 810 Baffle-Type Loudspeaker, 384, Oct.
SCALE Distortion—Again, by "Cathode Ray," 392, Nov.
 Schools Equipment, List of Approved Sets (News), 261, July
 Scottish Gee Chain (News), 370, Oct.
 Seafarers' Receiver, Eddystone Model 670, 365, Oct.
 See-Saw Circuit Again, by J. McG. Sowerby, 447, Dec.
 Selectivity in Television Amplifiers, by W. T. Cocking, 204, June; (Correspondence), 386, Oct.
 Series Capacitor Heater Circuits, by A. W. Stanley, 332, Sept.; (Correspondence), 385, Oct.; 426, Nov.
 Set Manufacture, Control Relaxed (News), 430, Dec.
 Ship-Shore Radiophone in Thames (News), 224, June
 Short-wave Broadcasting (Editorial), 39, Feb.; (Correspondence), 73, Feb.
SHORT-WAVE CONDITIONS, by T. W. Bennington and L. J. Prechner, 10, Jan.; 52, Feb.; 115, Mar.; 125, Apr.; 191, May; 216, June; 263, July; 303, Aug.; 334, Sept.; 378, Oct.; 423, Nov.; 463, Dec.
 --- Propagation Survey, 1947, by T. W. Bennington, 44, Feb.
 Shunt Voltage Stabilizer, by J. McG. Sowerby, 200, June
 Single-diaphragm Loudspeakers, by A. Cecil Barker, 217, June
 --- Slideband Selector, by A. Dinsdale, 244, July
 --- Valve A.F. Oscillator, by K. C. Johnson, 82, Mar.
 --- F.M. Converter, Fremodyne, 96, Mar.
 Slot Aerials, by D. A. Bell, 57, Feb.
 Smith-Rose, Dr. R. L., Director of Radio Research (News), 53, Feb.
 Society of Relay Engineers (News), 24, Jan.
 Societies and Clubs, Lists, 109, Mar.; 230, June
 Stabilized Power Supplies, by M. G. Scroggie, 373, Oct.; 415, Nov.; 453, Dec.
 Standard Frequency Transmissions (News), 293, Aug.; D.S.I.R. Statement, 322, Sept.

1948

Standards: Electromagnetic Units and
 Deviations, by Geoffrey Stedman, 406,
 Nov.
 Superlatives, Revolt against (Editorial), 239,
 July; (Correspondence), 346, Sept.
 Super-regeneration, Against (Correspondence),
 265, July.
 Supersonic High Fidelity? R.S.A. Discussion
 (News), 23, Jan.
 Suppressing Electrical Interference (News),
 100, Mar.
 Surgeless Volume Expansion (Correspondence),
 234, June; (Correction), 347,
 Sept.
 "Surplus" Television Receiver, by L. J.
 Dalby, 251, July.
 Switch Contacts, Cleaning, 51, Feb.;
 (Correspondence), 194, May.
 Symbol of Inconstancy? (Correspondence),
 111, Mar.; 154, Apr.; 346, Sept.
 Synchrony, The, by "Cathode Ray," 277,
 Aug.

T.C.C. Cathodray Tubular Capacitors, 282,
 Aug.
T.R.E. Open Day, 258, 259, July.
 Taylor Electrical 415 Moving-coil Meter,
 384, Oct.
 ——— New Rotary Switches, 404, Nov.
 Technicians' Salaries (News), 100, Mar.
 Television and Thunderstorms (Correspondence),
 75, Feb.
 — E.H.T. Supply, by A. H. B. Walker, 1:
 Required Characteristics, 120, Apr.;
 2: Voltage Multipliers, 169, May;
 (Correction), 215, June
 — Picture Size, by "Cathode Ray" 16,
 Jan.
 — Receiver Construction, Note and
 Correction, 19, Jan.; Answers to
 Queries, 219, June; Handy Parts
 Components, 405, Nov.

Television Standards, 381, Oct.; (Editorial),
 351, Oct.; (Correspondence), 74, Feb.;
 426, Nov.
 — Test Pattern, 137, Apr.
 — Waveforms, 439, Dec.
 Terminology (News), 260, July; (Correspondence),
 305, Aug.
 — Navy's Proposals (News), 224, June
 — Revolt against Superlatives (Editorial),
 239, July; 346, Sept.
 Test Equipment, Marconi Instruments, 203,
 June
 Time Delay Flip-Flop (Circuits: Electronic
 Circuitry), 379, Oct.
 Tonal Balance (Correspondence), 113, Mar.
 Transformerless Television Receiver, Pye
 B1ST, 338, Sept.
 "Transistor" Amplifying Crystal, 358,
 Oct.
 Transmission on 7 Mc/s, by W. Oliver, 25,
 Jan.
 Transmitting Capacitor, Eddystone, 220,
 June
 Tropicalizing Equipment, 269, July

U.S.A. 1-mile Television Tower (News), 143,
 Apr.
 U.S. Television Standstill (News), 450, Dec.
 Ultra Electric D570, W570 and W470
 Television Receivers, 449, Dec.
 UNBIASED, by Free Grid, 32, Jan.;
 72, Feb.; 114, Mar.; 147, Apr.;
 192, May; 232, June; 264, July;
 304, Aug.; 344, Sept.; 372, Oct.;
 424, Nov.; 464, Dec.
 United Insulator Co. Ceramic Capacitors,
 282, Aug.; 325, Sept.

V.H.F. for Civil Aircraft, 242, July
 Valve Standardization (Correspondence), 265,
 July
 Varley DP61 Output Transformer, 325, Sept.
 Vibrator Power Packs, by D. A. Bell, 272,
 Aug.
 Vidor Portable Record Player, 446, Dec.
 Voltage Stabilizer, Shunt, by J. McG.
 Sowerby, 200, June
 Volume Expansion, Surgeless (Correspondence),
 234, June; (Correction), 347,
 Sept.

WESTINGHOUSE Brake & Signal Co.,
 Jubilee, 412, Nov.
 Weymouth B5 Coil Pack and I.F. Trans-
 former, 281, Aug.
 — Two-Range Permeability Tuner, 325,
 Sept.
 What is Good Reproduction? B.B.R.A.
 Discussion, 20, Jan.
 Why Align Discriminators? by Thomas
 Roddam, 240, July; by A. G.
 Crocker, 312, Sept.; (Correspondence),
 386, Oct.; 425, Nov.
 Wilkins & Wright Record Groove Indicator,
 384, Oct.
 Wire Broadcasting Survey (News), 370, Oct.
 Wireless Telegraphy Bill (Editorial), 431,
 Nov.
 Wireless World Television Receiver, Note and
 Correction, 19, Jan.; Answers to
 Queries, 219, June; Handy Parts
 Components, 405, Nov.
 Wolsey Television Aerial, 50, Feb.
WORLD OF WIRELESS, 21, Jan.; 53,
 Feb.; 100, Mar.; 143, Apr.; 180,
 May; 223, June; 259, July; 293,
 Aug.; 335, Sept.; 369, Oct.; 411,
 Nov.; 450, Dec.

CLASSIFIED INDEX

(All entries except Books, Illustrations and Authors also appear in the General Index.)

AERIALS

Broadcast Aerial Standardization (News),
 180, May
 Slot Aerials, by D. A. Bell, 57, Feb.

DESIGN

Amplifier, Economical 50-watt, by G. R.
 Woodville, 457, Dec.
 Amplifiers with Negative Feedback (Correspondence),
 233, June; 347, Sept.
 Battery-set Indicators (Correspondence), 266,
 July
 Broadcast Receivers, Price of (Editorial),
 271, August.
 Discriminators, Why Align? by Thomas
 Roddam, 240, July; by A. G. Crocker,
 312, Sept.; (Correspondence), 386,
 Oct.; 425, Nov.
 Electronic Circuitry, by J. McG. Sowerby,
 249, July; 283, Aug.; 321, Sept.;
 379, Oct.; 403, Nov.; 444, Dec.
 F.M. Reception, by D. Maurice and R. J. H.
 Slaughter, 103, Mar.; (Correspondence),
 193, May
 Full-wave Detection (Correspondence), 306,
 Aug.
 High-level Detection, by W. MacLanachan,
 330, Sept.; (Correspondence), 194,
 May; 426, Nov.; 465, Dec.
 High-Quality Amplifier Design, by P. J.
 Baxandall, 2, Jan.; (Correction),
 71, Feb.
 High-Stability LC Oscillator, by Thomas
 Roddam, 286, Aug.
 Negative Feedback Calculations, by E. J.
 James, 326, Sept.
 New-Look Crystal Sets, by R. G. Hibberd,
 210, June
 Push-pull Input Circuits, by W. T. Cocking,
 1: General Principles, 7, Jan.
 2: Cathode-follower Phase-splitter,
 62, Feb.
 3: Phase Reversers, 85, Mar.
 4: The Anode Follower, 126, Apr.
 5: Cathode-coupled Stage, 183, May
 Quiet High-gain Amplifier, by C. C. White-
 head, 208, June; (Correction), 384, Oct.
 Radiated Interference (Correspondence), 113,
 Mar.

Reducing Heater Hum, by K. G. Britton with
 P. E. Baylis, 360, Oct.; (Correspondence),
 467, Dec.
 Series Capacitor Heater (Circuits, by A. W.
 Stankey, 332, Sept.; (Correspondence),
 385, Oct.; 426, Nov.
 Shunt Voltage Stabilizer, by J. Mett. Sowerby,
 200, June
 Single Sideband Selector, by A. Dinadale,
 244, July
 Single-valve F. M. Converter, Fremodyne,
 98, Mar.
 Stabilized Power Supplies, by M. G. Scroggie,
 373, Oct.; 415, Nov.; 453, Dec.
 Synchrony, The, by "Cathode Ray,"
 277, Aug.
 Vibrator Power Packs, by D. A. Bell, 272,
 Aug.

ELECTRONICS

Cable and Wireless Phototelegraphy Equip-
 ment (News), 21, Jan.
 Electronics and Atomic Energy, by E. W.
 Titterton, 40, Feb.
 Electronics and Space Flight, 27, Jan.
 Harwell Atomic Energy Research Establish-
 ment, 323, Sept.
 Industrial Electronic Apparatus, by D. W.
 Thomasson, 88, Mar.
 Megohmmeters, Electronic, by H. G. M.
 Spratt, 354, Oct.

MANUFACTURERS' PRODUCTS

A.W.F. Loudspeaker Cone Assemblies, 276,
 Aug.
 Ace Radio Model 600, 307, Aug.
 Albert Mfg. Co. Condenser Scale and Drive,
 282, Aug.
 Albion Coil Packs, 99, Mar.
 Allander Industries A801 Battery Receiver,
 195, May
 Amateur Radio Equipment, R.S.G.B. Show,
 14, Jan.
 Ambassador 4756 Radiogramophone, 462,
 Dec.
 Antiference Television Aerials, 384, Oct.
 B.T.H. CS7A Silicon Detector, 210, June
 — Crystal Rectifier, 155, Apr.

Brierley Ribbon Pickup, 306, Aug.
 British Communications Corp. L59 and L45
 Walkie-Talkies, 409, Nov.
 British Mechanical Productions P.T.F.E.
 Insulator, 405, Nov.
 Burgoyne Electric Soldering Gun, 247, July
 — Aerial Connector, 61, Feb.
 Bush Model EBS4: Test Report, 214, June
 Cawell A. F. Measurement Service, 195,
 May
 Celco Carbon Resistors, 269, July
 Cinema-Television Universal Oculoscope, 99,
 Mar.
 Clive Courtenay Television Pre-Amplifier, 61,
 Feb.
 Cossor 487 A.C. Console, 220, June
 — 912 Television Receiver, 404, Nov.
 — Harbour Radar, 130, Apr.; 317, Sept.
 — Radar in France, 418, Nov.
 Decca Frequency Test Records, 211, June
 — "Grr" Pickup, 364, Oct.
 Denco Coil Turret, 154, Apr.
 Dynatron "Nucleonic" Equipment, 436,
 Dec.
 E.M.I. C.P.S. Television Camera, 60, Feb.;
 320, Sept.
 Eddystone Transmitting Capacitor, 220, June
 — 145-Mc/s Tuning Unit, 405, Nov.
 — Seafarers' 670 Receiver, 365, Oct.
 Ekco CR61, Car Radio, 445, Dec.
 — Civil Aircraft Equipment, 242, July
 — Consolette A.C./D.C. Portable, 462, Dec.
 — Princess Portable, 195, May
 — Model A52: Test Report, 94, Mar.
 — U75 A.C./D.C. Superhet, 307, Aug.
 Electro Methods Pre-Set Resistors, 446, Dec.
 Eta Pre-Set Tuner Unit, 298, Aug.
 Everett Edgcombe Kilo-volt-ampere Meter,
 61, Feb.
 G.E.C. BC1941 Portable, 220, June
 — BC956 Battery Set, 320, Sept.
 — BT7094 Radio/Television Receiver, 520,
 Sept.
 — Multi-Channel Communication System,
 93, Mar.
 Goodmans' Twin-Diaphragm Loudspeaker,
 155, Apr.
 Gramplan 3512/15 P.M. Loudspeaker, 320,
 June

v.54 1948

Handy-Parts W. F. Television Receiver Components, 405, Nov.
 Hermes "Radio Tourist" Portable, 17, Feb.; (Correspondence), 99, Mar.
 Invicta Radio 31 Superhet, 195, May
 — 91G Radiogramophone, 462, Dec
 — 22 Battery Superhet, 384, Oct.
 — 200 A.C./D.C. Superhet, 266, July
 K.B. DR10, DR15 and DR20 Receivers, 462, Dec.
 Kresta Car Radio, 285, Aug.
 Labgear Pre-amplifier Converter, 282, Aug.
 M.R. Supplies Multi-ratio Output Transformer, 247, July
 Mallory Batteries Mercury Cell, 167, May
 Marconi Instruments Test Equipment Exhibition, 203, June
 — Quartz Crystals, 207, June
 Meteor Electronics Midget Coils, 99, Mar.
 Miers Sound Reinforcement System, 325, Sept.
 Mullard-Hallcrafters Agreement (News), 295, Aug.
 — New Valves, 446, Dec.
 — Sub-miniature Valves, 80, Mar.; (Correspondence), 193, May
 Murphy Radio A.C. and Universal Receivers, 195, May
 — A124 Baffle-type Receiver, 320, Sept.
 Parmeko "Mercury" Transformers and Chokes, 446, Dec.
 Philips 383A and 663A Television Receivers, 404, Nov.
 — A.C./D.C. Receiver, 99, Mar.
 — 474B Battery Superhet, 307, Aug.
 Plessey-Bendix Agreement (News), 337, Sept.
 — Coaxial Connectors, 404, Nov.
 — Ediswan Agreement (News), 371, Oct.
 — Microwave Equipment, 179, May
 Progress in Components, R.C.M.F. Exhibition, 131, Apr.
 Pye B18T A.C./D.C. Television Receiver, 338, Sept.
 — M78F Miniature Portable, 307, Aug.
 Radiomobile 100 Car Radio: Test Report, 48, Feb.
 — 4020 Car Radio, 445, Dec.
 Rainbow Radio 848 Receiver, 462, Dec.
 Richard Allen Radio 810 Baffle-type Loud-speaker, 384, Oct.
 Schools Equipment, List of Sets (News), 261, July
 Sperry Gyroscope Harbour Radar, 317, Sept.
 T.C.C. Cathodray Tubular Capacitors, 282, Aug.
 Taylor Electrical 415 Moving-Coil Meter, 384, Oct.
 — New Rotary Switches, 404, Nov.
 Tele-Radio Development Miniature F.M. Transmitter-Receiver, 35, Jan.
 Ultra D570, W570 and W470 Television Receivers, 449, Dec.
 United Insulators Ceramic Capacitors, 282, Aug.; 325, Sept.
 Varley DP61 Output Transformer, 325, Sept.
 Vidor "Kalium" Cell, 352, Oct.; (Correspondence), 467, Dec.
 — Portable Record Player, 446, Dec.
 Ward Blenkinsop Printed Circuits, 220, June
 Weymouth B5 Coil Pack and I.F. Transformer, 281, Aug.
 — Two-range Permeability Tuner, 325, Sept.
 Wilkins & Wright Record Groove Indicator, 384, Oct.
 Wolsey Television Aerial, 59, Feb.

MISCELLANEOUS

Aerial Corona Interference, by F. R. W. Strafford, 441, Dec.
 Air Communications, S.B.A.C. Display, 366, Oct.
 Air-Line Radio, 28, Jan.
 Amplifying Crystal, 358, Oct.
 Cleaning Switch Contacts, by J. J. Payne, 51, Feb.; (Correspondence), 194, May
 Coil-Pack Modification, by L. Miller, 59, Feb.
 Components for Amateurs (Correspondence), 75, Feb.; 112, Mar.
 Degrees for Ex-Servicemen (Correspondence), 112, Mar.
 Electromagnetic Units and Definitions by Geoffrey Stedman, 406, Nov.
 Gas Molecules as Resonators, 248, July

Impregnated Windings (Correspondence), 74, Feb.
 Inapt Nomenclature (Correspondence), 111, Mar.
 India's New Stations (News), 182, May
 Invisible Components, by "Cathode Ray," 459, Dec.
 "j" What it is, and How to Use it, by "Cathode Ray," 68, Feb.
 Load—or Burden, by "Cathode Ray," 107, Mar.
 N.P.L. Annual Exhibition (News), 293, Aug.
 Navigational Films (News), 23, Jan.
 Negative Frequency, by "Cathode Ray," 361, Oct.
 Nomenclature (Editorial), 311, Sept.
 Phase, by "Cathode Ray," 187, May; 227, June
 Price Freezing of Receivers (News), 145, Apr.
 Record Library (News), 294, Aug.
 Resistor Ratings, by H. G. M. Spurr, 419, Nov.; (Correspondence), 466, Dec.
 Scottish Gee Chain (News), 370, Oct.
 Ship-Shore Radiophone in Thames (News), 224, June
 Standard Frequency Transmissions (News), 293, Aug.
 Superlatives, Revolt against (Editorial), 239, July; (Correspondence), 346, Sept.
 Super-regeneration, Against, (Correspondence), 265, July
 Symbol of Inconstancy (Correspondence), 111, Mar.; 153, Apr.; 346, Sept.
 Terminology (News), 290, July; (Correspondence), 305, Aug.
 Wire Broadcasting Survey (News), 370, Oct.

MODULATION

Frequency Modulation, by "Cathode Ray," 339, Sept.
 Hifau: E.H.F. A.M. Broadcasting in U.S.A., 297, Aug.
 Modulation, etc., by "Cathode Ray," 253, July
 Single-valve Converter, 96, Mar.

ORGANIZATION

A.S.E. now Admiralty Signal and Radar Establishment (News), 55, Feb.
 Amateur Examination Results (News), 370, Oct.
 — Frequencies (News), 335, Sept.; 370, Oct.
 — Operators' Qualifications (Correspondence), 34, Jan.
 Atlantic City Conference Recommendations (Editorial), 79, Mar.
 — Findings, 148, Apr.
 B.B.C. Annual Reports (News), 143, Apr.; 369, Oct.
 — Board of Management (News), 21, Jan.
 — F.M. and A.M. (Editorials), 199, June; 239, July
 Midland Television Frequencies (News), 411, Nov.
 — Norwich Station Site, (News), 335, Sept.
 — services (Correspondence), 33, Jan.
 — Scientific Advisory Committee, 259, July
 — Silver Jubilee (News), 101, Mar.
 — Takes over Singapore Station (News), 335, Sept.
 Television Standards (Editorial), 351, Oct.; (News), 369, Oct.; (Article), 381, Oct.
 B.R.F.M.A. Annual Report (News), 53, Feb.
 Brit. I.R.E. Officers (News), 452, Dec.
 Better Listening (Correspondence), 426, Nov.
 "Business Radio" (Editorial), 159, May; (News), 143, Apr.; 180, May; Frequencies, 224, June
 Components for Export, R.C.M.F. Exhibition (Editorial), 119, Apr.
 Director of Radio Research D.S.I.R. (News), 53, Feb.
 E.H.F. Broadcasting (Editorials), 199, June; 239, July; (Correspondence), 266, July; 305, Aug.; 425, Nov.
 Engineers' Guild (News), 145, Apr.
 Europe's New Broadcasting Frequencies (Editorial), 391, Nov.; List, 397, Nov.
 European Regional Broadcasting Conference (News), 224, June; 259, July
 F.M. and Monopoly (Correspondence), 34, Jan.; 74, Feb.; 112, Mar.; 153, Apr.

I.E.L. "Scientific Radio" Convention, 100, Mar.
 Council and Radio Section Committee, 295, Aug.
 Institute of Recorded Sound Formed (News), 144, Apr.
 Physical Society Exhibition (News), 55, Feb.; Report, 174, May
 Post Office Control (Editorial), 1, Jan.
 Wind Wireless (News), 290, July
 Purchase Tax on Batteries (News), 21, Jan., on P.A. Gear (News), 225, June, 337, Sept.; on Receivers (News), 180, May; 259, July; on Pickups (News), 294, Aug.; on Records (News), 336, Sept.; on Valves (News), 21, Jan., 259, July; (Correspondence), 347, Sept.; on Kits (News), 259, July; 269, Oct.
 R.C.M.F. Components Exhibition (News), 55, Feb.; 119, 131, Apr.
 — Broadcast Aerial Standardization (News), 180, May
 — Council (News), 226, June
 — Stocking Show (News), 335, Sept.; 443, Dec.
 R.N.V. (W.) R. Reconstituted (News), 450, Dec.
 R.S.G.B. Membership (News), 55, Feb.
 — Headquarters Station (News), 335, Sept.
 R.T.E.B. Television Examination (News), 260, July
 Radio Amateurs' Examination Results, 29, Jan.
 Radio & Television Trade Federation Formed (News), 102, Mar.
 Radio Equipment of Buildings (Editorial), 271, Aug.
 Radio Service Trade Register (News), 100, Mar.
 Radiolympia, Future of (Editorial), 79, Mar.
 Set Manufacture, Control Relaxed (News), 450, Dec.
 Short-wave Broadcasting Under Fire (Editorial), 39, Feb.; (Correspondence), 73, Feb.
 Society of Relay Engineers (News), 24, Jan.
 Standard Frequency Transmissions (News), 193, Aug.; D.S.I.R. Statement, 322, Sept.
 Technicians' Salaries (News), 100, Mar.
 Wireless Telegraphy Bill (Editorial), 432, Dec.

PROPAGATION

Ionosphere Review 1947, by T. W. Bennington, 41, Feb.
 Investigating Anomalous Propagation (News), 181, May
 Short-Wave Conditions, by T. W. Bennington and L. J. Prechner, 10, Jan.; 52, Feb.; 115, Mar.; 125, Apr.; 191, May; 216, June; 263, July; 303, Aug.; 334, Sept.; 378, Oct.; 423, Nov.; 463, Dec.
 Television and Thunderstorms (Correspondence), 75, Feb.

RADAR

Douglas Harbour Radar 130, Apr.
 Harbour Radar at Liverpool, by R. F. Hansford, 317, Sept.; (Editorial), 311, Sept.
 Marconi on Radar, 1922 Forecast, 427, Nov.
 Marine Applications of Radar (Editorial), 311, Sept.
 Watson-Watt's First Radar Patent (News), 53, Feb.

SOUND REPRODUCTION

Amplifier, Direct-coupled, (Correspondence), 260, July; 345, Sept.; 386, Oct.; 425, Nov.; 465, Dec.
 Artificial Acoustic Reflectors (Correspondence), 111, Mar.; 265, July
 B.S.R.A. Conference & Exhibition, 267, July
 Commercial Disc Recording, I.E.E. Paper, 67, Feb.
 Does Distortion Matter? I.E.E. Discussion, 97, Mar.
 Economical 50-watt Amplifier, by G. R. Woodville, 457, Dec.
 Government Hearing Aid, 11, Jan.
 H.F.: Necessary and Nice? (Correspondence), 34, Jan.; 111, Mar.; 265, July

High-Quality Amplifiers (*Correspondence*), 33, Jan.
 Magnetic Recording (*Correspondence*), 112, Mar.; 154, Apr.; 235, June
 Monitoring Loudspeakers, Physical Society Paper, 186, May
 Multitone Hearing Aid, 357, Oct.
 Parasitic Oscillations (*Correspondence*), 265, July
 "Phasitron," Kinematograph Society Paper, 168, May
 Push-Pull Input Circuits, by W. T. Cocking, 1: General Principles, 7, Jan.; 2: Cathode-follower Phase-splitter, 62, Feb.; 3: Phase Reversers, 85, Mar.; 4: The Anode Follower, 126, Apr.; 5: Cathode-coupled Stage, 183, May
 Pickup, Brierley Ribbon, 306, Aug.
 Quality in the Home, by H. S. Casey, 299, Aug.; (*Correspondence*), 346, Sept.; 466, Dec.
 Scale Distortion—Again, by "Cathode Ray," 392, Nov.
 See-saw Circuit Again, by J. McG. Sowerby, 447, Dec.
 Single-diaphragm Loudspeaker, by A. Cecil Barker, 217, June
 Supersonic High Fidelity, R.S.A. Discussion (*News*), 23, Jan.
 Surgeless Volume Expansion, (*Correspondence*), 234, June; (*Correction*), 347, Sept.
 Tonal Balance (*Correspondence*), 113, Mar.
 What is Good Reproduction? B.S.R.A. Discussion, 20, Jan.

TELEVISION

Aircraft and Television Interference (*Correspondence*), 306, Aug.; 386, Oct.; 425, Nov.
 Australian Television (*News*), 371, Oct.
 B.B.C. Television Standards (*Editorial*), 351, Oct.; (*News*), 369, Oct.; (*Article*), 381, Oct.
 British and American Standards Compared, 439, Dec.
 C.P.S. Emitron Camera, 60, Feb.; 320, Sept.
 Deflector Coil Efficiency, by W. T. Cocking (*Correction*), 35, Jan.
 E.H.T. Supply, by A. H. B. Walker, 1: Required Characteristics, 129, Apr.; 2: Voltage Multipliers, 169, May; (*Correction*), 215, June
 Frame Deflector-coil Efficiency, by W. T. Cocking, 289, Aug.
 French High-Definition Television (*News*), 411, Nov.; 450, Dec.
 French Television (*News*), 53, Feb.
 1-mile Television Tower (*News*), 143, Apr.
 International Television Conference (*News*), 335, Sept.; 370, Oct.
 London-Birmingham Television Link (*News*), 143, Apr.
 Long-range Television (*Correspondence*), 235, June; 345, Sept.; 426, Nov.; (*News*), 450, Dec.
 Midland Television Frequencies (*News*), 411, Nov.
 --- Map, 212, June
 Planless Television (*Correspondence*), 305, Aug.
 Selectivity in Television Amplifiers, by W. T. Cocking, 204, June; (*Correspondence*), 386, Oct.
 Suppressing Electrical Interference (*News*), 100, Mar.
 "Surplus" Television Receiver, by L. J. Dalby, 251, July
 Television at Copenhagen Exhibition (*News*), 369, Oct.
 --- Picture Size, by "Cathode Ray," 16, Jan.
 Standards, 381, Oct.; (*Editorial*), 351, Oct.; (*Correspondence*), 74, Feb.; 426, Nov.
 Test Pattern, 137, Apr.
 Thunderstorms and Television (*Correspondence*), 75, Feb.
 Transformerless Television Receiver, Pye B1M, 348, Sept.
 U.S. Television Standstill (*News*), 450, Dec.
 Wireless World Television Receiver, Note and (*Correction*), 19, Jan.; Answers to Queries, 219, June; Handy Parts Components, 405, Nov.

TEST AND MEASUREMENT

A.C. Bridges, by "Cathode Ray," 139, Apr.
 A.F. Measurement Service, 195, May
 Cathode-ray Oscilloscope, by S. A. Knight, 432, Dec.
 Electronic Megohmmeters, by H. G. M. Spratt, 354, Oct.
 General-Purpose Oscilloscope, by J. F. O. Vaughan, 159, May
 Marconi Instruments Test Equipment, 203, June
 Output Transformer Efficiency, by A. E. Falkus, 26, Jan.
 Radio Interference Measurement, 359, Oct.
 Single-valve A.F. Oscillator, by K. C. Johnson, 82, Mar.

TRANSMISSION

Dynamic Distortion Detector, by R. Danziger, 213, June
 Frequency Shift Keying, by Thomas Roddam, 400, Nov.
 Low-power Transmission, by W. Oliver, 25, Jan.
 "Personal" Radio Telephones, 409, Nov.
 Reducing F.M. Bandwidth, by A. G. Chambers, 221, June

VALVES AND THERMIONICS

British Sub-miniature Valves, 80, Mar.; (*Correspondence*), 193, May
 Cathode-ray Tube Data, by D. W. Thomasson, 296, Aug.
 Valve Standardization (*Correspondence*), 265, July
 Valve Symbols, (B.S.1409:1947), 71, Feb.
 Velocity-modulation Valve for Millimetre Wavelengths, 258, July

BOOKS

A.C. Network Analysis by Symbolic Algebra, W. H. Miller (*Review*), 410, Nov.
 Abatement of Interference, B.S.I. CP1001:1947; (CP1002:1947, 427, Nov.
 Amateur Radio Relay League Handbook, 1948, 168, May
 Amplification and Distribution of Sound, A. E. Greenless, 410, Nov.
 Applied Electronics, D. Hyton Thomas, 309, Aug.
 B.B.C. Year Book, 1948, 143, Apr.
 British Standards Year Book, 1947, 182, May
 Broadcast Reception: Sound and Television by Radio, BS327:201 (*Editorial*), 271, Aug.
 Cossor Marine Radar, 226, June
 Crystal Rectifiers, (Vol. 15, M.I.T.) Henry C. Torrey and Chas. A. Whitmer, 267, July
 E.R.A. Anti-interference Reports, 165, May
 Electric-Motor Control Gear, J. L. Watts, 267, July
 Electrical Engineer Reference Book, 1948, E. Molloy, M.G. Say and R. C. Walker, 267, July
 Electronic Circuits and Tubes, Harvard University (*Review*), 151, Apr.
 Electronic-Valve Bases, Caps and Holders, BS448:1947, 92, Mar.
 Electronics and Their Application in Industry and Research, Edited by Bernard Lovell (*Review*), 30, Jan.
 F.B.I. Register of Manufacturers, 22, Jan.
 Fundamental Principles of Ionosphere Transmission, R.B.B., 309, Aug.
 Fundamental Research Problem of Telecommunications, D.S.I.R., 213, June
 Fundamentals of Radio, Jordan, Nelson, Osterbrock, Pumphrey and Smeby (*Review*), 30, Jan.
 Glossary of Terms used in Waveguide Technique, Supplement to BS204:1943, 380, Oct.
 Graphical Symbols for Telecommunications, BS530:1948, 368, Oct.; (*Article*), L. H. Bainbridge-Bell, 437, Dec.
 Hartley-Turner Technical Bulletins, 219, June
 Journal of Institute of Navigation (*News*), 146, Apr.
 Klystron Tubes, A. E. Harrison (*Review*), 66, Feb.
 Loudspeakers: The Way and How of Sound Reproduction, G. A. Briggs, 309, Aug.
 Marine Radar: Performance Standards, M.I.T., 223, June
 Microwave Mixers, R. V. Pound (M.I.T. Vol. 16) (*Review*), 216, June
 Microwave Technique, J. H. Shankland and E. D. Hart, 108, Mar.
 Microwave Transmission Design Data, Theodore Moreno, 309, Aug.
 Micro-Waves and Wave Guides, H. M. Barlow (*Review*), 92, Mar.; (*Correspondence*), 153, Apr.
 Modern Home-Built Telesvisor, *Electronic Engineering*, 31, Jan.
 Notes on Soldering, Tin Research Institute (*Review*), 456, Dec.
 One Story of Radar, A. P. Rowe, 380, Oct.
 "Partridge Manual," Partridge Transformers, 191, May
 Photoelectric Cells in Industry, R. C. Walker, 309, Aug.
 Principles of Electrical Engineering, T. F. Wall, 92, Mar.
 Principles of Radar, Denis Taylor and C. H. Westcott (*Review*), 331, Sept.; (*Correspondence*), 386, Oct.
 Radio Aids to Navigation, R. A. Smith (*Review*), 30, Jan.
 Radio Data (Charts (New Edition), 12, Jan.
 Radio Engineering, Vol. 1, E. K. Sandeman (*Review*), 152, Apr.
 Radio Receivers and Transmitters, 2nd Edition, S. W. Amos and F. W. Kellaway, 331, Sept.
 Radio Valve Practice, B.R.V.M.A., 405, Nov.
 Radio's Conquest of Space, D. McNicol, 410, Nov.
 Regulations for the Electrical Equipment of Ships, I.E.E. (Supplement), 10, Jan.
 Second Year Radio Technology, W. H. Date, 331, Sept.
 Seizième Rapport Annuel, S.S.R. 1946, 31, Jan.
 Sound Recording by the Direct Disc Method, D. O'C. Roe, 197, May
 Standard Valve Data, S.T.C., 252, July
 Symbolic Method of Vector Analysis, W. H. Miller (*Review*), 410, Nov.
 Television Simply Explained, R. W. Hallows (*Review*), 248, July
 Test Papers and Solutions on Electrical Engineering, T. F. Wall, 92, Mar.
 Theory and Application of Microwaves, A. B. Bronwell and R. E. Beam (*Review*), 152, Apr.
 These You Can Hear, W. Norman Stevens, 66, Feb.
 Trader Year Book, 1948, 182, May
 Twenty-five Years of British Broadcasting, B.B.C., 101, Mar.
 Ultra- and Extreme-Short Wave Reception, M. J. O. Strutt (*Review*), 92, Mar.
 Valve Symbols, BS1409:1947, 71, Feb.
 Valve Technique, D. N. Corfield and P. V. Cundy (*Review*), 284, Aug.
 World Radio and Television Annual, Edited by Gale Pedrick, 66, Feb.
 World Radio Handbook for Listeners, O. Lund Johansen (*News*), 146, Apr.
 Wörterbuch der Elektrotechnik, G. Swoboda and R. Filppowsky, 410, Nov.

ILLUSTRATIONS

APPLETON, Sir Edward, 22, Jan.
 BROWN, S. G., 336, Sept.
 Burrows, Arthur, 23, Jan.
 CONTROL Room for Olympic Games, 335, Sept.
 DONISTHORPE, H. de A., 225, June
 FERRANTI, Sir Vincent de, 54, Feb.
 GOLDUP, T. E., 294, Aug.
 HAYNES Radio HR88 Table Television Receiver, 469, Dec.
 Hughes, J. R., 102, Mar.
 KEMP, R. J., 101, Mar.
 LLOYD, W. J., 412, Nov.
 MAP of World showing "Frequency Allocation" Regions, 149, Apr.
 --- showing Disposition of London-Birmingham Television Link, 212, June
 Marconi Lightweight Radio Installation A197/108, 96, Mar.
 Memorial Plaque at Laverock, 200, July

v.54 1-7Y

Mechanical Handling at E.M.I. Factory, 226, June
Mobile Receiver for Measuring Millimetre-Wave Absorption, 413, Nov.

PICTURE Telegraphy—New Cable & Wireless Equipment, 21, Jan.
Plessey Press-Button Record Player, 452, Dec.

Pye Television Camera at Copenhagen Exhibition, 412, Nov.
—Two-Way Taxi Radio, 22, Jan.

RADAR Reflector for Life-boat, 293, Aug.
Railway Radio in Rome, 150, Apr.
Reed, Dr. Morris, 145, Apr.
Rise-Grain Valves, 180, May
Ridge-way, J. W., 101, Mar.
Ryde, J. W., 181, May

SMALE, J. A., 101, Mar.
Smith, A. J., 225, June
Smith, Frederick, 295, Aug.
Smith-Rose, Dr. R. L., 54, Feb.
Sutherland, F. Neil, 101, Mar.

TELEVISION-F.M. Mast for Birmingham (Sketch), 411, Nov.
Television O.B. Gear, 320, Sept.
Television Field Trials, G.E.C., 143, Apr.

UNITED Nations Radio Station, K2UN, 259, July

WILLIAMS, Dr. R. C. G., 101, Mar.
Wire Recorder-Reproducer and Disc Recorder (Wireway), 261, July

AUTHORS

BAINBRIDGE-BELL, L. H., 437, Dec.
Barker, A. C., 217, June
Baxendall, P. J., 2, Jan.

Bell, D. A., 57, Feb.; 272, Aug.
Bennington, T. W., 10, Jan.; 44, 52; Feb.; 115, Mar.
Bennington, T. W. and Prechner, L. J., 125, Apr.; 191, May; 216, June; 263, July; 303, Aug.; 334, Sept.; 378, Oct.; 423, Nov.; 463, Dec.
Britton, K. G., 360, Oct.

CASEY, H. S., 299, Aug.
"Cathode Ray," 16, Jan.; 68, Feb.; 107, Mar.; 139, Apr.; 187, May; 227, June; 253, July; 277, Aug.; 339, Sept.; 361, Oct.; 392, Nov.; 459, Dec.

Chambers, A. G., 221, June
Cocking, W. T., 7, Jan.; 62, Feb.; 85, Mar.; 126, Apr.; 183, May; 204, June; 289, Aug.
Crocker, A. G., 312, Sept.

DALBY, L. J., 251, July
Danziger, R., 213, June
"Diallist," 36, Jan.; 76, Feb.; 116, Mar.; 156, Apr.; 196, May; 236, June; 268, July; 308, Aug.; 348, Sept.; 388, Oct.; 428, Nov.; 468, Dec.

Dinsdale, A., 244, July

FALKUS, A. E., 26, Jan.
Free Grid, 32, Jan.; 72, Feb.; 114, Mar.; 147, Apr.; 192, May; 232, June; 264, July; 304, Aug.; 344, Sept.; 372, Oct.; 424, Nov.; 464, Dec.

HALLOWS, R. W., 166, May; 352, Oct.
Hansford, R. F., 317, Sept.
Hibberd, E. G., 210, June

JAMES, E. J., 326, Sept.
Johnson, K. C., 82, Mar.

1948
KNIGHT, S. A., 482, Dec.

MACLANACHAN, W., 330, Sept.
Maurice, D., and Slaughter, R. J. H., 103, Mar.

Miller L., 59, Feb.

OLIVER, W., 25, Jan.

PAYNE, J. J., 51, Feb.
Prechner, L. J., with Bennington, T. W., 125, Apr.; 191, May; 216, June; 263, July; 303, Aug.; 334, Sept.; 378, Oct.; 423, Nov.; 463, Dec.

RODDAM, Thomas, 240, July; 286, Aug.; 400, Nov.

SCROGGIE, M. G., 373, Oct.; 415, Nov.; 453, Dec.;
Slaughter, R. J. H., with Maurice, D., 103, Mar.

Sowerby, J. McG., 200, June; 249, July; 283, Aug.; 321, Sept.; 379, Oct.; 403, Nov.; 447, Dec.

Spratt, H. G. M., 354, Oct.; 419, Nov.
Stanley, A. W., 332, Sept.
Stedman, G., 406, Nov.
Strafford, F. R. W., 441, Dec.

TARZIAN, Sarkes, 297, Aug.
Thomasson, D. W., 88, Mar.; 296, Aug.
Titterton, E. W., 40, Feb.

VAUGHAN, J. F. O., 160, May

WALKER, A. H. B., 120, Apr.; 169, May
Whitehead, C. C., 208, June
Woodville, G. R., 457, Dec.

13